

Space Air- Conditioning by Aqua Ammonia Absorption System using Exhaust Waste Heat of Diesel Generator Set

Vakkar Ali

Department of Mechanical and Industrial Engineering, Majmaah University, Majmaah, Kingdom of Saudi Arabia,
w.ahmad@mu.edu.sa

Ziaur Rehman

Department of Civil and Environmental Engineering, Majmaah University, Majmaah, Kingdom of Saudi Arabia,
z.rehman@mu.edu.sa

Abstract

The present work is an experimental analysis for space air conditioning system. The absorption system is using the exhaust waste heat energy of a diesel generator engine of 11.20 kW. The present study is carried out to use waste heat energy in an absorption air-conditioning system. A wooden test room of 3.375 m³ capacity is built to simulate the air-conditioned space. The obtained results show that performance of the system in terms of COP decreases with increase in condenser and absorber temperatures and is directly proportional to the generator and evaporator temperatures of the space air-conditioning system. The condenser, evaporator and absorber temperatures of the system are recorded and it is found that the effect of these temperatures on COP of the air-conditioning system ranges 0.64 to 0.94. It was found that the designed air-conditioning system is capable of generating the estimated cooling load without consuming extra energy. The main advantage of the system is low operational cost of air-conditioning system and environmental hazards.

Keywords: Aqua Ammonia; Absorption system; Exhaust gas heat; Space Air-conditioner; Waste heat.

1. Introduction

Energy sources in Saudi Arabia describe petroleum production, consumption and export, but also natural gas and electricity production. Saudi Arabia is the world's largest crude petroleum producer and exporter. The 90% of the total country export and 75% revenues [1] depend on the petroleum products. The economy is still very dependent on oil in spite of diversification efforts, in especially petrochemical industry. In 2011, the export was 10.82 million barrels per day (1.7142×10^6 m³/d) of petroleum [1]. While most of this is exported, along with domestic use is rapidly increasing, primarily for electricity production and automobile transportation sector but the large portion of the oil is being used for domestic electricity demand in the country. As of January 2007, Saudi Aramco's proven reserves were estimated at 259.9 billion barrels (41.32×10^9 m³), comprising about 24% of the world total [2], 85% of the Saudi oil fields found have not produced oil yet, it would last for 90 years at the above said rate of production. Some energy experts are convinced that the current reserves are substantially lower than those officially claimed by Saudis and that the depletion rate is substantially faster [3]. The Kingdom's consumption of its own oil production has steadily increased and it now consumes about one quarter of its oil production (approximately three

million barrels per day) [3]. According to Jim Karne, 'Saudi Arabia now consumes more oil than Germany', an industrialized country with triple the population and an economy nearly five times as large' [3, 4]. The only way to reduce energy consumption would be to reduce input in energy producing devices or systems. Saudi Arabia is the fastest growing electricity consumer in the Middle East, particularly of transportation fuels. In 2005, Saudi Arabia was the world's 15th consumer of primary energy, of which over 60% was petroleum based. The remainder was made of natural gas [5]. The Saudi Government has approved the construction of a \$300 million facility to turn waste into energy. The facility will process 180 Tons of waste per day, producing 6 MW of electricity and 250,000 US gallons of distilled water [6], therefore it is clear that the country is really thinking in the direction of waste energy saving schemes. The carbon dioxide emissions also increasing day by day in the country due to highly consumption of petroleum products in 2009 the country was the 15th top carbon dioxide emitter per capita that was 18.56 tons per capita [7].

Therefore, the country dependence on petroleum products for long term should be decreased as much as possible to move towards the use of renewable energy or the optimal use of waste energy sources. Moreover,

extensive use of fossil results in environmental hazards like global warming, greenhouse effect, depletion of ozone layer, climate change and acid rain. The future scenario of Saudi Arabia is full of use renewable, waste and others alternative sources of energy. In stationary diesel engine like diesel electric generator about 33% waste heat energy goes with exhaust gas of the engine, this energy could be useful to run many thermal system, like heat exchanger, vapor absorption generator and boiler to heat the working fluid and use it for useful work. The shaft work in mechanical compressor requires energy so that increases the on the engine, therefore an increase in fuel consumption, exhaust emissions, and engine operating parameters. Using waste heat of the engine we can save fuel consumption as well as the impact of emissions on the global environment.

Table 1: Energy in Saudi Arabia

Year	Capita Million	Primary Energy TWh	Production TWh	Export TWh	Electricity TWh	CO ₂ Emission Mt
2004	24.0	1,633	6,469	4,811	148	324
2007	24.2	1,748	6,412	4,606	175	358
2008	24.7	1,879	6,734	4,796	187	389
2009	25.4	1,836	6,145	4,324	199	410
2010	27.4	1,969	6,258	4,551	219	446
2012	28.08	2,176	6,998	4,700	227	457
Change 2004-10	14.6%	20.6%	-3.3%	-5.4%	48%	37%

Nomenclature:

- m = mass flowrate of exhaust gas, kg/s
- C_p = specific heat, kJ/kg °C
- T_o = outlet temperature, °C
- T_i = inlet temperature, °C
- T_g = generator temperature, °C
- T_c = condenser temperature, °C
- r.p.m. = revolution per minute
- COP = coefficient of performance
- Q_{gen} = heat generated, kW
- Q_{evap} = amount of heat absorbed in the evaporator, kW

2. Literature Review

Diesel engines are mostly used for power

generation due to their low cost and high thermal efficiency. Diesel engines have become popular for their use in all type of power generation stations [8]. Many scientists have been studied power generation plant with other energy saving plants using C.I. engines.

Many researchers conducted studies on absorption air-conditioning using waste heat energy Robert and Frosch [8]. Bingahadi *et al* [9], Franket *et al* [10], Alhuseinand Inayatullah [11] fabricated and designed a simple aqua ammonia absorption system automobile air- conditioning using the waste heat of exhaust from a S.I engine. Gui *et al* [12] and Masadeh [13] investigated aqua ammonia air-conditioning system for automobile utilizing the exhaust energy of a S.I engine. Al-Aqeeli and Gandhsadan [14] analyzed the feasibility and design of an air conditioning system for automobile using the absorption approach with LiBr-H₂O as working fluid. Shah Alam [15] studied a model of air-conditioning system using the exhaust waste heat of four cylinder four stroke passenger car and used three working fluid (NH₃, H₂, and H₂O) in vapor absorption system. Silva *et al* [16]. Crepinsek *et al* [17] studied the performance of different working fluid used in absorption air-conditioning cycle for mobile system [18]. It is clear from the investigations of many researchers result to absorption refrigeration systems only few researchers studied the possibility of using waste heat of internal combustion engine for useful work as absorption refrigeration systems because, in the present era a large amount of waste heat energy is released to the environment without using for beneficial work [19-20].

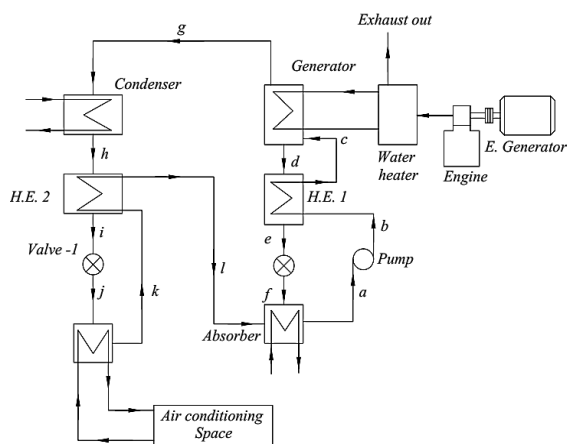

Fig. 1: schematic diagram of absorption system coupled with electric diesel generator

It is well none from the available literature and investigations of the researchers that utilization of

waste heat from the internal combustion engine for absorption air conditioning system. A large amount of research papers has been published on the use of waste heat from diesel engine and few only attempts have been made to attach the air-conditioning system to the small diesel power generation units like 20-30kW capacity. Hence, the main purpose of this present work is to see the feasibility to utilize the waste heat energy of a 20 kW diesel engine electric generator for the vapor absorption air-conditioning system and to replace the conventional vapor compression system for air-conditioning purpose. The feasibility of such type air-conditioning systems with large scale diesel power plants in Saudi Arabia will be advantageous in coming future to reduce the fuel consumption, adverse impact of emission on environment and make the power systems more economic. The proposed electric load for the year 2018 is 51,200 MW [21] and approximately 20--30 % of this energy is going with exhaust gas which is a huge amount of energy that can be utilized for useful work to reduce the consumption of fossil fuels up to some extent and harmful emissions to the environment. The main refrigeration cycle load can be reduced by using the waste heat energy of diesel engine and get two advantage such as cooling effect as well as reduction in emissions.

3. System Description

The complete schematic diagram of absorption air conditioning system with 11.20 kW diesel engine electric generator is shown in Fig. 1 (specification see in Table 2) which installed in the Mechanical Engineering laboratory of Al-Falah College of Engineering and Technology, Dhauj Faridabad, Haryana, India and used for the said experiment. The absorption air-conditioning system uses a binary mixture of ammonia and water and both referred as refrigerant and absorber having high stability for a wide range of operating conditions temperature and pressure. The system performance is highly dependable on the refrigerant latent heat of vaporization of ammonia. In this system, two heat exchanger with rectifying column are used to improve performance. The generator is used to generate the ammonia vapor using the waste heat of diesel engine and rectified with the help of rectifying column installed near it. The strong solution of ammonia and water from the absorber at state (a) is pumped to the condensing pressure level and preheat it in the heat exchanger to reduced heating at state (c).



Fig. 2: Photo Image Diesel Engine with Electric Generator

The hot water heated by the exhaust gas of the engine is fed in to the generator to heat the strong solution of ammonia and water and the weak solution goes to the rectifying column at state (d) and the ammonia at state (g). The weak solution of ammonia and water is fed to heat exchanger and then flows through the expansion valve and finally goes to the absorber at State (f). The ammonia vapor is fed to the air cooled condenser at state (g) for cooling. The condensate enters the heat exchanger for cooling further up to a state (i) and then goes to the expansion valve. In the expansion valve, the pressure is reduced to evaporator pressure level and then fed to evaporator at state (j) here the liquid refrigerant absorbs the heat and changes the phase due to absorbing latent heat of vaporization and produces cooling effect for required air conditioning system. After passing through the evaporator the refrigerant is further heated in heat exchanger-2 at state (l) and then is fed to the absorber for the next cycle.

Table 2: Diesel engine specifications of electric generator

S.No.	Name of parameter	Quantity
1.	Name of Company	Shakti Man, Single phase, 220 V, 50Hz
2.	Number of cylinder	1
3.	Type	Vertical cylinder
4.	Cooling	Water cooled
5.	Capacity	11.20 kW
6.	R.P.M.	1050
7.	Compression ratio	17:1
8.	Bore size	1.7 mm

3.1. Thermal analysis for experimental investigation

The experiment was conducted in the laboratory of department of Mechanical Engineering at Al-Falah College of Engineering and Technology, Dhauj Faridabad, Haryana, India. The air-conditioning space which has 800 cubic feet volume was found satisfactory or comfort cooled and the load was estimated 1.25 ton [14] of refrigeration for outside temperature 45°C and 25°C as the inside temperature range. The cooling load of the space is almost constant and design for 3 persons sitting and doing work on computer was found 2.43 kW. The room was perfectly insulated with thermocol sheet and not exposed to the sun from any side. The cooling load capacity is measured in kW which is the heat amount removed from the air-conditioning space. The exhaust gas heat is being utilized as an energy source input to generator of the absorption system. The amount of heat energy using for heating the water in cross flow heat exchanger can be estimated by [19, 20] using the below relation.

$$Q_{gen} = mC_p (T_o - T_i) \quad (1)$$

The analysis of absorption cycle Fig. 1, the heat flow from each component shows and thermal calculations for heat transfer results were done for the comparison to the reported work found in literatures. In absorption system the cooling effect is produced in the evaporator which termed as Q_{evap} (amount of heat absorbed by the refrigerant). The coefficient of performance of said absorption cycle [20] is given by below relation.

Coefficient of performance (C.O.P.) = Heat absorbed in evaporator/ Heat given to the generator

$$C.O.P. = \frac{Q_{evap}}{Q_{gen}} \quad (2)$$

where, Q_{evap} is the amount of heat absorbed in the evaporator refrigerant and Q_{gen} is the amount of heat given to the generator for heating the ammonia water solution.

The denominator is more important for the thermodynamic analysis and coefficient of performance because this heat is recovered of waste heat of exhaust gas of the diesel engine.



Fig. 3: Photo Image of waste heat absorption system

4. System specifications and design

In vapor compression system the compressor is used to increase the temperature and pressure of refrigerant vapor up to the stage of condenser while in vapor absorption system the same activity is done by the generator where the waste from the exhaust is utilized. The generator absorbs the heat of hot water heated by the waste gas and heats the strong solution of $NH_3 + H_2O$, and evaporates the ammonia from the mixture and then fed to condenser. The main factor in system design especially for generator is which is relatively large than vapor compression system. The designed dimension is shown in the Table 1. The actual details of design and consideration will not be shown in presented paper because limitations are not allowed to explain in wide range. The relations, Correlation and thermodynamic analysis for the whole system are taken from the references [15, 17, 18, 19, 20]. The generator takes the heat the heat from hot water coming from water heater at 95°C for this purpose a shell and tube heat exchanger is used with 32 tubes and having 1.25 cm diameter made by copper. The exhaust gas is used to heat the water in the heat exchanger. Now the hot water of the heat exchanger is being fed to generator to heat ammonia water solution. The exhaust gas exhausted to the atmosphere directly after using its heat in the water heat exchanger. The condenser is cooled by the water available in the laboratory at room temperature. The specification of various components like vapor absorption assembly, capacity of generator, generator pressure, tube length, overall heat transfer coefficient, total heat transfer area and generator temperature are given in the Table 3.

Table 3: System specifications

S.NO.	Name of item	Dimension
1.	Vapor absorption assembly with generator	Length-75cm,Width-45cm and height- 25 cm
2.	Generator heating capacity	3.516 kW
3.	Generator temperature	95 °C
4.	Generator pressure	2×10^6 Pa
5.	Over all heat transfer coefficient U	6.892 W/m ² °C
7.	The total heat transfer Area A	0.3489 m ²
8.	Tube length	5.98 m

5. Results and Discussion

When the system is operated for air-conditioning purpose the generator-set is started. The analysis is carried out when the performance of the diesel engine is stabilized. Otherwise the results may be affected and deviated up to some extent. In this attempt the effect of engine load, exhaust gas temperature, exhaust flow rate and engine speed on the performance of space air conditioner are analyzed. The performance of the space air-conditioner will be affected by the temperature of evaporator (Cooling coil), generator, absorber, and condenser. The temperature of flue gasses is directly proportional to the speed of the generator engine and also flow rate increases with increase in speed. The energy with the exhaust gasses affects the performance of air conditioning system. It is depicted from Fig. 2, the energy and temperature of the exhaust gasses is directly proportional to the engine generator engine speed also clear that cooling effect of the system increases with increase if generator set speed. The variation in increment of the gas temperature and energy will not be continued more after speed of 1000 r.p.m. This is because of the maximum rate of evaporation of ammonia in the generator that imposes the limit on heat supply to generator and further change in positive direction of heat input to the system would not be beneficial to increase the performance for the space air-conditioning system. Another disadvantage at higher speed of generator set engine is more wear and tear in the moving parts which is again responsible for cost factors. It is generally found that electric generators are used for peak loads and high speed of engine most of the time. Therefore, the performance

of system will not be affected more at moderate speeds of generator set engine. Hence it is advisable to get optimized value of performance (Cooling effect) of the system to run the engine at moderate engine load and speed.

It is depicted from Fig. 4 that the exhaust gas temperature increases with increase the generator engine load and speed meaning that more heat will be given to the system. It is seen from the results for load ranging from 25% to 75% on the generator set engine, the exhaust gas maximum temperatures are 235 °C and 275 °C respectively. This range of temperature is quietly more than the temperature available at the speed ranging from 600 to 1100 r.p.m.

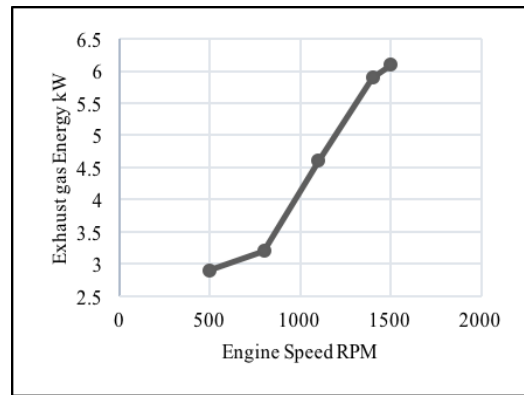

Fig. 4: Variation of diesel engine speed with the exhaust heat generation

It has been shown from Fig. 5 that the heat of generator increases with increasing the exhaust gas temperature. As equation 2 shows, the higher the value of Q_g lower the value of C.O.P of air conditioning system.

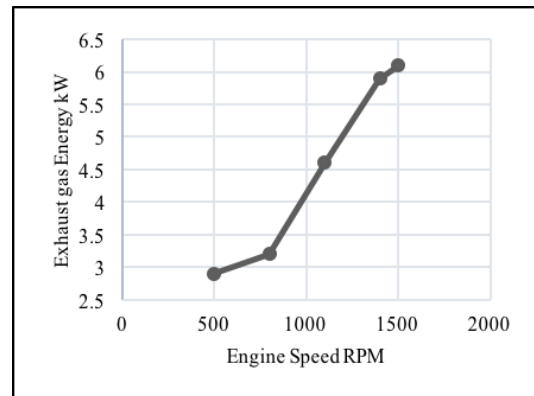

Fig. 5: Variation of diesel engine speed with the exhaust gas temperature

Fig. 6, shows the variation between the C.O.P and evaporator temperature when the generator temperature $T_g = 95\text{ }^\circ\text{C}$ and condenser temperature $T_c = 40\text{ }^\circ\text{C}$. The performance of evaporator is increased by increasing the temperature from $5\text{ }^\circ\text{C}$ to $15\text{ }^\circ\text{C}$ this is because of increment in latent heat of vaporization of the evaporator liquid fluid.

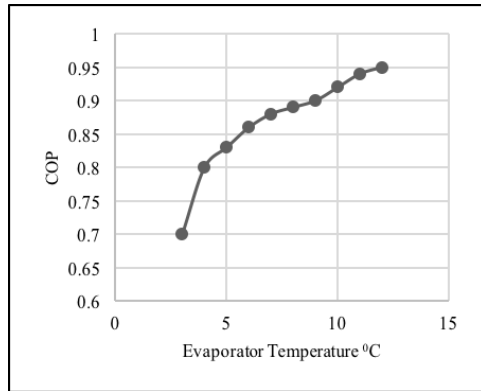

Fig. 6: Variation of COP with evaporator temperature

It has been shown from Fig. 7 that the heat of generator increases with increasing the exhaust gas temperature. As equation 2 shows, the higher the value of Q_g lower the value of C.O.P of air conditioning system.

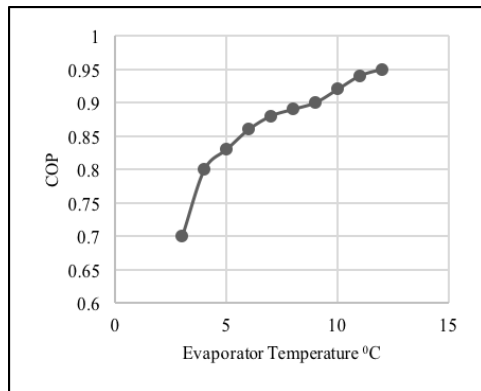

Fig. 7: Variation of exhaust gas temperature with heat generation Q_g

The trend of variation between the C.O.P and condensing temperature is shown in Fig. 8. It is clear from the characteristics of the condenser the greater the temperature of the condenser the more will be the heat rejected through it in the surrounding and this would be responsible to increase the net heat gain in the evaporator. It should be noted that the capacity of the evaporator is constant during the experiment.

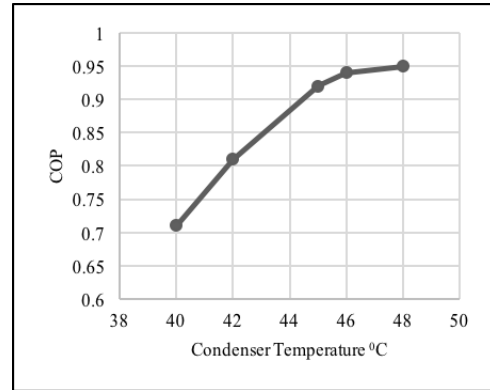

Fig. 8: Variation of COP with condenser temperature

Fig. 9 shows the variation of heat generated with C.O.P of the air-conditioning system that at constant heat capacity of the evaporator the performance of the system is higher at lower value of generator heat and moderate engine speeds.

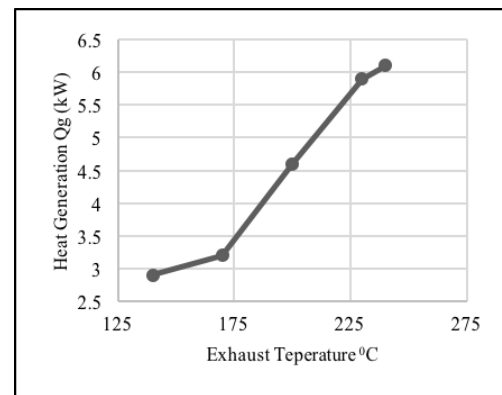

Fig. 9: Variation of COP with heat generation Q_g

6. Conclusions

Space air-conditioning system using waste energy from diesel gen set has been carried out in this investigation. The C.O.P highly depends on the working conditions of absorber, generator, condenser, and evaporator temperature. The ammonia absorption for space air-conditioning is an economically better concept for using exhaust gas heat. In this system the input comes from the exhaust gases, and very small amount of electric energy is used to operate the mechanical pump. Therefore it is advantageous to use the exhaust gas heat to operate space air conditioner for cooling purpose. The low performance of the system having poor economic advantage. This system can be an alternative of vapor compression system. With low maintenance, low level of noise and high reliability

system can be utilized commercially for space air conditioning.

References

- [1]. "The world Fact book-Saudi Arabia" (<https://www.cia.gov/library/publications/the-world-factbook/geos/sa.html>) Cia.gov. Retrieved 2011-04-28
- [2]. Saudi Aramco History (<http://www.saudiaramco.org>)
- [3]. <http://www.simmonsco-intl.com/files/Kuwait%20Talk.pdf>
- [4]. House, Karen Elliott (2012). On Saudi Arabia: Its People, past, Religion, Fault Lines and Future. Knopf. p. 245.
- [5]. Ministry of Water and Electricity – SAMIRAD (Saudi Arabia Market Information Resource)" (<http://www.saudinf.com/main/c6x.htm>). Saudinf.com. 2009-04-20. Retrieved 2011-04-28
- [6]. Energy Information Agency, Country Analysis Briefs 2007". (<http://www.eia.gov/>) Eia.doe.gov. Retrieved 2011-04-28.
- [7]. World carbon dioxide emissions data by country: China speeds ahead of the rest (<http://www.theguardian.com/news/datablog/2011/jan/31/world-carbon-dioxide-emissions-country-data-co2>) Guardian 31 January 2011
- [8]. Robert A, Frosch. Automotive absorption air conditioner utilizing solar and motor waste heat, United States Patent; 1980, 4,307,575.
- [9]. Bin Gadhi S, Agrawal R , and Kaushik. Computer aided analysis and thermal design of a signal effect absorption unit using Methanol-LiBr.ZnBr2 mixture. Proceedings of the International Conference on Refrigeration and Air Conditioning, (Amman – Jordan); 1988, p.25-30.
- [10]. Frank F, Nekola, Trenton F. Heat generator for use with an absorption air conditioning system for Automobiles 1990; United State Patent, 5: 49-82.
- [11]. Alhusein M, Inayatullah. Automobile vapor absorption air conditioning system, J of Mu'tah for Research and studies 1994; 9:.251-269.
- [12]. Gui-ping Lin Xiu-gan Yuan Zhi-guang Mei, The feasibility study of the waste heat air-conditioning system for automobile, J of Thermal Science 1994; 3:2,
- [13]. Masadeh. S. Design and performance of automobile aqua-ammonia A/C System utilizing exhaust waste heat. Master Thesis, University of Jordan; 2002.
- [14]. Al-Aqeeli N, Gandhidasan P. The use of an open cycle absorption system in automobile as an alternative to CFC. The 6th Saudi Engineering Conference, KFUPM, Dhahran, December 2002; Vol. 5. P. 517-530.
- [15]. Shah Alam A. Proposed model for utilizing exhaust heat to run automobile air-conditioner, International Conference on "Sustainable Energy and Environment, 21-23 November 2006, Bangkok, Thailand.
- [16]. Silva CM, Costa .M and. Farias. Evaluation of SI engine exhausts gas emissions upstream and downstream of the catalytic converter, J Energy Conversion and Management 2006; 47: 2811–2828.
- [17]. Crepinsek Z, Goricanec D, Kroppe J. Comparison of the performances of absorption refrigeration cycles. J of WSEAS Transaction on Heat and Mass Transfer 2009; 3:65-76.
- [18]. Koehler J, Tegethoff WJ, Westphalen D, Sonnekalb M. Absorption refrigeration system for mobile applications utilizing exhaust gases. J Heat and Mass Transfer 1997; 32: 333–340.
- [19]. Holman JP. Heat Transfer, 9th ed. New York: McGraw-Hill; 2002.
- [20]. Mc Queiston C, Jerald P. Heating, Ventilating, and Air conditioning Analysis & Design. 4th ed. John Wiley & Sons, New York; 1997
- [21]. <http://www.eia.doe.gov/emeu/cabs/Saudi.html>