



COLLEGE OF ENGINEERING

VICE DEANSHIP FOR QUALITY AND DEVELOPMENT

LAB EQUIPMENT BOOKLET

Contents

No.	Subject	Page
I	Introduction	2
II	Equipment of Electrical Engineering Department Labs	3
III	Equipment of Mechanical and Industrial Engineering Department Labs	57
IV	Equipment of Civil and Environmental Engineering Department Labs	84
V	Acknowledgement	141

INTRODUCTION

This booklet is a guideline for the equipment, apparatus and tools available at the labs of the college of engineering at Majmaah University, KSA.

The booklet is issued under the supervision of the vice deanship for quality and development at the college of engineering.

The data for the booklet was collected by the lab advisors in all the academic departments in the college of engineering.

The data for the booklet was categorized by the occupational and environmental health unit at the college of engineering.

The purpose of issuing this booklet is to list and identify all the main equipment, apparatus and tools available at the labs of the college of engineering at Majmaah University.

The booklet will also act as a guideline for all the visitors of the labs at the college of engineering.

PART ONE

ELECTRICAL ENGINEERING DEPARTMENT

EQUIPMENT IN THE LABS

Electrical Engineering Department
Electric Circuits Lab 205
Courses Related to Lab: EE 202

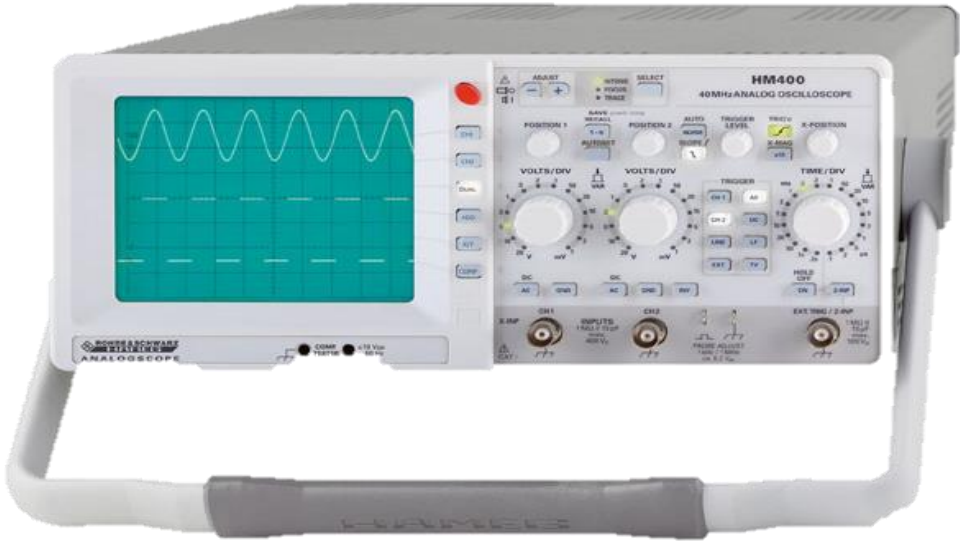
Equipment Name	40 MHz Analog Oscilloscope HM400
Brief Description	<p>Use. To display and analyze the waveform of electronic signal.</p> <p>Specifications.</p> <ul style="list-style-type: none"> • Reference-Class in Sensitivity and Input Voltage Range • 2 Channels with Deflection Coefficients 1 mV/div....20 V/div., variable up to 50 V/div. • Time Base 100 ns/div....0.2 s/div., with X Magnification to 10 ns/div. • Low Noise Measuring Amplifiers with high Pulse Fidelity and minimum Overshoot • Peak to Peak Trigger for stable Triggering 0 to 50 MHz at 0.5 div. Signal Level (up to 80 MHz at 1 div.) • Auto set, Save/Recall Memories for 6 Instrument Settings • Yt- and XY-Mode with Z-Input for Intensity Modulation • Component Characterization with Component Tester • (two Terminal Network Measurement) • Low Power Consumption
Equipment Photo	
Safety Guidance	<ol style="list-style-type: none"> 1. Do not operate the oscilloscope with the case removed 2. Use only 3-wire outlet 3. Excessive voltage applied to the input jacks may damage the oscilloscope. 4. Never obstruct the ventilating holes. 5. Never allow a small spot of high brilliance to remain stationary on the screen for more than few seconds.

Equipment Name	Function generator FG-32
Brief Description	<p>Use: Generate different type of electric waveform over a wide range of frequencies.</p> <p>Specifications:</p> <ul style="list-style-type: none"> • Frequency: 0.5 Hz ~ 3 MHz in 6 Steps, controller by rotary switch • Output Waveform: Sine, Square, Triangle, Ramp, Positive Pulse and Negative Pulse; 6 waveform total • Stability: 0.1 % - 15 Minutes power-on <ul style="list-style-type: none"> ○ 0.2 % - 24 hrs after power-on • DC offset: Continuous Adjustment 10V at no load or 5 V at 50 load • Limits of Operation: 0°C ~40 °C 10 to 80 %RH • Power source: AC 115V, Fuse 600 mA, AC 220V fuse 300 mA • Power consumption: 25 W • Dimensions: 27.5 x 9.0 x 30.0 cm • Weight: 2.5 Kg
Equipment Photo	
Safety Guidance	<ol style="list-style-type: none"> 1. Excessive voltage applied to the input jacks may damage the function generator. 2. NEVER place heavy objects on FG. 3. NEVER place a hot soldering iron or near the FG. 4. NEVER obstruct the ventilating holes. 5. NEVER move or pull the FG with power cord or probe cord. 6. Use only 3-wire outlet 7. NEVER apply external voltage to output BNC of FG

Equipment Name	GW INSTEK GPS-4303 DC Power Supply, 30 V / 3 A
Brief Description	<p>Use. Supply constant voltage (max 30V) and constant current (3A)</p> <p>Specifications.</p> <ul style="list-style-type: none"> • 2, 3 and 4 Independent Isolated Output • Four "3 Digits" LED Displays • 0.01% Load and Line Regulation • Low Ripple and Noise • Tracking Operation and Auto Series/Parallel Operation • Output ON/OFF Switch • Output Voltage and Current Setting When Output Disable • Fan Speed Control Circuit to Minimize Fan Noise • Over Load and Reverse Polarity Protection • Optional European Jack Type Terminal
Equipment Photo	
Safety Guidance	<ol style="list-style-type: none"> 1. Excessive voltage applied to the input jacks may damage the function generator. 2. NEVER obstruct the ventilating holes. 3. Use only 3-wire outlet 4. Do not use power supply in a place where ambient temperature exceed 40°C 5. NEVER move or pull the FG with power cord or probe cord.

Equipment Name	GW INSTEK GDM-451 Compact Handheld Digital Multimeter
Brief Description	<p>Use. It combines several measurement functions in one handheld unit.</p> <p>Specifications.</p> <ul style="list-style-type: none"> • DMM Functions: AC/DC Current, AC/DC Voltage, Capacitance, Continuity, Frequency, Resistance, Temperature • Current Measure DC Max: 20A • Voltage Measure AC Max: 750V • Voltage Measure DC Max: 1kV • Resistance Measure Max: 200Mohm • DMM Response Type: Average • Display Count: 19999 • No. of Digits: 4.5 • Range Selection: Auto, Manual • Current Measuring Range AC: 20mA to 20A

	<ul style="list-style-type: none"> • DMM Type: Hand Held • Temperature Measuring Range: -40°C to +1000°C • Current Measuring Range DC: 2mA to 20A
<p>Equipment Photo</p>	
<p>Safety Guidance</p>	<ol style="list-style-type: none"> 1. To prevent damage or injury install Quick acting fuses with standard AMP/VOLT rating 2. Connect correctly the wires in parallel and series to measure voltage and current respectively. 3. Remove all connections and wiring before changing the battery of DMM

Electrical Engineering Department
Logic Design Lab 208
Courses Related to Lab: EE 207

Equipment Name	Advanced Digital Training System ETS-5000
Brief Description	Use The design of Advanced Digital Training System is easy to operate and easy to understand.
	Specifications <ul style="list-style-type: none"> • Solderless breadboard : AD-222 • DC power supply: Fixed DC output : + 5V, 1 A, Fixed DC output : -5V, 300 mA, Variable DC output : +3V ~ +15V, 500mA, Variable DC output : - 3V ~ - 15V, 500mA • Mode selector switch: When the switch is put on "TTL" or "CMOS" position, the input or output of pulse generator, pulser switches, 8 bits data switches, digital probe, 8 bit LED display will meet the HI or • LO level of "TTL" or "CMOS" • Two digits of 7-segment LED display • Pulse generator : Duty cycle : 50%, Frequency range : 1 Hz ~ 10 Hz, Amplitude : 0 ~ 10Vpp, TTL/CMOS mode output, TTL : + 5V • CMOS : +VDC (depends on the + VDC output) • Eight bits LED display : Set mode selector switch to "TTL" position • Two pulser switches : A,A,B,B output • Output level : TTL : HI = 5V, LO = 0.1V, CMOS : HI = + VDC, LO = 0.1V • Eight data switches : TTL : HI = 5V, LO= 0V, CMOS : HI = +VDC, LO = 0V • Digital probe: Set mode selector switch to "TTL" position • Universal connector : It reserves fixed holders on the panel in order to be connected with various connectors • Dimension 325 x 250 x 95 mm (L x W x H) • Weight : 4.3kg
Equipment Photo	
Safety Guidance	<ol style="list-style-type: none"> 1. Keep away from water 2. NEVER connect parts wet hands, causes electric shock.

3. After use, always keep back in the case.

Electrical Engineering Department

Electric Circuits Lab 212

Courses Related to Lab: EE 111

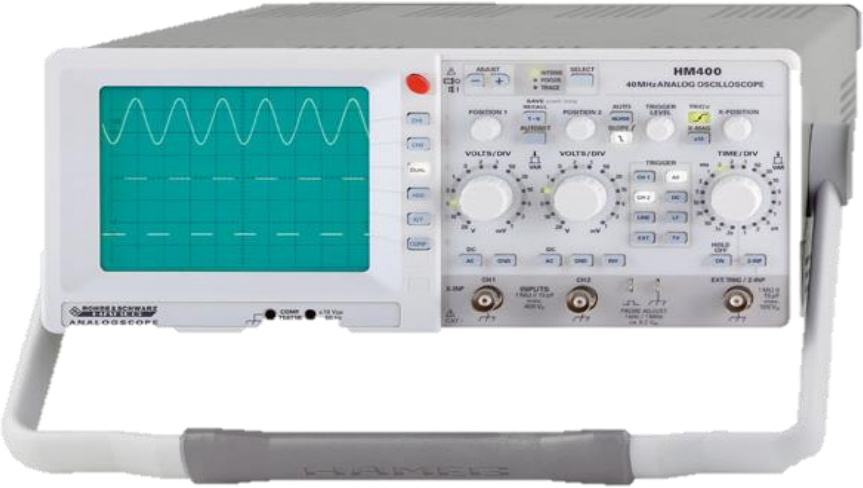
Equipment Name	40 MHz Analog Oscilloscope HM400
Brief Description	<p>Use: To display and analyze the waveform of electronic signal.</p> <p>Specifications:</p> <ul style="list-style-type: none"> • Reference-Class in Sensitivity and Input Voltage Range • 2 Channels with Deflection Coefficients 1 mV/div....20 V/div., variable up to 50 V/div. • Time Base 100 ns/div....0.2 s/div., with X Magnification to 10 ns/div. • Low Noise Measuring Amplifiers with high Pulse Fidelity and minimum Overshoot • Peak to Peak Trigger for stable Triggering 0 to 50 MHz at 0.5 div. Signal Level (up to 80 MHz at 1 div.) • Auto set, Save/Recall Memories for 6 Instrument Settings • Yt- and XY-Mode with Z-Input for Intensity Modulation • Component Characterization with Component Tester • (two Terminal Network Measurement) • Low Power Consumption
Equipment Photo	
Safety Guidance	<ol style="list-style-type: none"> 1. Do not operate the oscilloscope with the case removed 2. Use only 3-wire outlet 3. Excessive voltage applied to the input jacks may damage the oscilloscope. 4. Never obstruct the ventilating holes. 5. Never allow a small spot of high brilliance to remain stationary on the screen for more than few seconds.

Equipment Name	Function generator FG-32
Brief Description	Use: Generate different type of electric waveform over a wide range of frequencies.
	Specifications: <ul style="list-style-type: none"> • Frequency: 0.5 Hz ~ 3 MHz in 6 Steps, controller by rotary switch • Output Waveform: Sine, Square, Triangle, Ramp, Positive Pulse and Negative Pulse; 6 waveform total • Stability: 0.1 % - 15 Minutes power-on <ul style="list-style-type: none"> ○ 0.2 % - 24 hrs after power-on • DC offset: Continuous Adjustment 10V at no load or 5 V at 50 load • Limits of Operation: 0°C ~40 °C 10 to 80 %RH • Power source: AC 115V, Fuse 600 mA, AC 220V fuse 300 mA • Power consumption: 25 W • Dimensions: 27.5 x 9.0 x 30.0 cm • Weight: 2.5 Kg
Equipment Photo	
Safety Guidance	<ol style="list-style-type: none"> 1. Excessive voltage applied to the input jacks may damage the function generator. 2. NEVER place heavy objects on FG. 3. NEVER place a hot soldering iron or near the FG. 4. NEVER obstruct the ventilating holes. 5. NEVER move or pull the FG with power cord or probe cord. 6. Use only 3-wire outlet 7. NEVER apply external voltage to output BNC of FG

Equipment Name	GW INSTEK GPS-4303 DC Power Supply, 30 V / 3 A
Brief Description	Use: Supply constant voltage (max 30V) and constant current (3A)
	Specifications: <ul style="list-style-type: none"> • 2, 3 and 4 Independent Isolated Output • Four "3 Digits" LED Displays • 0.01% Load and Line Regulation • Low Ripple and Noise • Tracking Operation and Auto Series/Parallel Operation • Output ON/OFF Switch

	<ul style="list-style-type: none"> • Output Voltage and Current Setting When Output Disable • Fan Speed Control Circuit to Minimize Fan Noise • Over Load and Reverse Polarity Protection • Optional European Jack Type Terminal
Equipment Photo	
Safety Guidance	<ol style="list-style-type: none"> 1. Excessive voltage applied to the input jacks may damage the function generator. 2. NEVER obstruct the ventilating holes. 3. Use only 3-wire outlet 4. Do not use power supply in a place where ambient temperature exceed 40°C 5. NEVER move or pull the FG with power cord or probe cord.

Equipment Name	GW INSTEK GDM-451 Compact Handheld Digital Multimeter
Brief Description	<p>Use: It combines several measurement functions in one handheld unit.</p> <p>Specifications:</p> <ul style="list-style-type: none"> • DMM Functions: AC/DC Current, AC/DC Voltage, Capacitance, Continuity, Frequency, Resistance, Temperature • Current Measure DC Max: 20A • Voltage Measure AC Max: 750V • Voltage Measure DC Max: 1kV • Resistance Measure Max: 200Mohm • DMM Response Type: Average • Display Count: 19999 • No. of Digits: 4.5 • Range Selection: Auto, Manual • Current Measuring Range AC: 20mA to 20A • DMM Type: Hand Held • Temperature Measuring Range: -40°C to +1000°C • Current Measuring Range DC: 2mA to 20A
Equipment Photo	
Safety Guidance	<ol style="list-style-type: none"> 1. To prevent damage or injury install Quick acting fuses with standard AMP/VOLT rating 2. Connect correctly the wires in parallel and series to measure voltage and current respectively.

	3. 3. Remove all connections and wiring before changing the battery of DMM
Electrical Engineering Department	
Principles of Electric Power and Machine Lab EE 271	
Courses Related to Lab: EE 270 and EE 288	

Equipment Name	Main Power Supply (DC and AC)
Equipment Photo	
Brief Description	Use: To implement the experimental programs of general electric measurements and of measurements applied to electric machines.
Specifications:	<ul style="list-style-type: none"> • Main control device 3 x 400 V / N / PE, 50-60 Hz, absorption 6 kVA • Service line with three-phase and single-phase socket • Fixed line of 220 Vdc – 20 A, • Variable three-phase line with neutral conductor of 0-430 Vac 8 A / 0-500 Vdc 8 A • Dimensions: 600 x 500 x 500 mm • Net weight: 50 kg
Safety Guidance	<ol style="list-style-type: none"> 1. Follow the proper switching on and off procedure 2. Press Emergency push button for any emergency 3. NEVER turn on power before your circuit is verified by TA. 4. NEVER use an exposed wire for the connection.
Equipment Name	Single-Phase Transformer Mod. P-13/EV
Brief Description	Use: To recognize the construction, different parts, terminals and ratings of the single phase transformer, to carry out the necessary tests to determine the parameters of the equivalent circuit and performance characteristics of the single phase transformer.
	Specifications: <ul style="list-style-type: none"> • Power: 1000 VA • Voltage of primary winding: 230 V 50 Hz • Voltage of secondary winding 1: 0-53-200-400V • Voltage of secondary winding 2: 0-115-230 V • Protection: IP 22

	<ul style="list-style-type: none"> • This unit also includes thermal protector • Dimensions: 360 x 200 x 300 mm • Weight: 21 kg
Equipment Photo	
Safety Guidance	<ol style="list-style-type: none"> 1. NEVER exceed the rated maximum current and voltages. 2. NEVER use short circuit test for more than few seconds 3. NEVER turn on power before your circuit is verified by TA. 4. NEVER use an exposed wire for the connection.

Equipment Name	Three-Phase Transformer Mod. P-14/EV
Brief Description	<p>Use: To recognize the construction, different parts, terminals and ratings of the three phase transformer, to carry out the necessary tests to determine the parameters of the equivalent circuit and performance characteristics of the three phase transformer.</p> <p>Specifications:</p> <ul style="list-style-type: none"> • Power: 1000 VA • Voltage of primary winding: 230/400/346V 50 Hz (*) • Delta/star/zigzag connection • Voltage of secondary winding: 230/400/346V (*) • Delta/star/zigzag connection • Protection: IP 22 • This unit also includes thermal protector • Dimensions: 360 x 200 x 300 mm • Weight: 27 kg
Equipment Photo	
Safety Guidance	<ol style="list-style-type: none"> 1. NEVER exceed the rated maximum current and voltages. 2. NEVER use short circuit test for more than few seconds 3. NEVER turn on power before your circuit is verified by TA. 4. NEVER use an exposed wire for the connection.

Equipment Name	TABLE CURSOR RHEOSTATS
Brief Description	Use:

	<p>Laboratory-type rheostats, wound on tubular ceramic core, wire-ends clamped with collars and connected to binding posts. Slider with silver-copper contacts; enclosed in perforated sheet-steel case, reported on Ø4-mm safety terminals; protection against indirect contacts with perforated sheet steel with IP 20 degree. Rheostats type RP-1 have only one resistance element, while the type RP-3 has three resistance elements.</p>
	<p>Specifications:</p> <ul style="list-style-type: none"> • GENERATOR SHUNT FIELD RHEOSTAT • Rheostat with differentiated winding sections • Power: 500 W • Current: 0.05 – 1A • Resistance value: 5000 Ohm • Terminals: 3 • Dimensions: 550x100x150 mm • Weight: 35 kg • FIELD SERIES RHEOSTAT • Power: 500 W • Current: 5.6A • Resistance value: 16 Ohm • Terminals: 3 • Dimensions: 550x100x150 mm • Weight: 3.5 kg
<p>Equipment Photo</p>	
<p>Safety Guidance</p>	<ol style="list-style-type: none"> 1. NEVER exceed the rated maximum current and voltages. 2. NEVER use the rheostat by keeping at minimum Resistance. 3. NEVER turn on power before your circuit is verified by TA. 4. NEVER use an exposed wire for the connection.

<p>Equipment Name</p>	<p>Reactive power compensation of an inductive load</p>
<p>Brief Description</p>	<p>Use: To study protective measures and electrical safety, setting up electrical machines and putting them into operation, use of starting circuits, assessment of electrical machine characteristics</p> <p>Specifications:</p> <ul style="list-style-type: none"> • In order to protect against overheating, the stator windings of the machines to be tested are equipped with temperature sensors. Should overheating occur, the machine test system automatically shuts down the test machine, thus preventing any damage to it. • The machines to be tested are equipped with an educationally designed terminal board with the winding configuration printed on it.

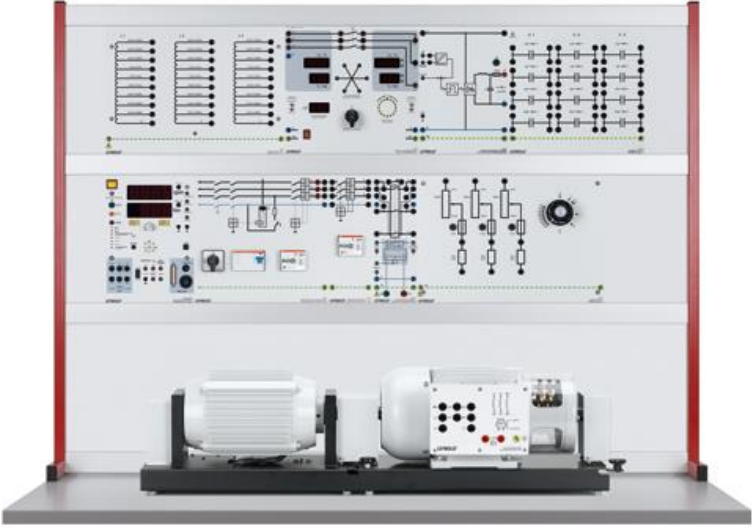
	<ul style="list-style-type: none"> • The ends of all the windings are connected to the terminal board and can be accessed via 4-mm safety sockets • Computer-supported acquisition of measurement data provides for meaningful measurement results. • Machines in the 1 kW rating class have a powerful and realistic operating response • In comparison to smaller machines, their characteristics display distinctive features related to the design.
Equipment Photo	
Safety Guidance	<ol style="list-style-type: none"> 1. NEVER exceed the rated maximum current and voltages. 2. NEVER use short circuit test for more than few seconds 3. NEVER turn on power before your circuit is verified by TA. 4. NEVER use an exposed wire for the connection.

Equipment Name	Direct-Current Motor /Generator With Separate / Compound Excitation Mod. P-1/EV
Brief Description	<p>Use: To recognize the construction, different parts, and rating of the separately excited DC motor, determine the performance characteristics of DC motor</p> <p>Specifications:</p> <ul style="list-style-type: none"> • Power: 1000 W • Armature voltage: 220 Vdc • Excitation voltage: 220 Vdc • Rpm.: 3000 • It also operates as DC motor • Form of construction: IM B3 • Protection: IP 22 • This unit also includes thermal protector • Dimensions: 500 x 200 x 300 mm • Weight: 48 kg

Equipment Photo	
Safety Guidance	<ol style="list-style-type: none"> 1. NEVER exceed the rated maximum current and voltages. 2. NEVER use short circuit test for more than few seconds 3. NEVER turn on power before your circuit is verified by TA. 4. NEVER use an exposed wire for the connection.

Equipment Name	Three-phase Synchronous Motor
Brief Description	<p>Use: The operation of a synchronous motor is due to the interaction of the magnetic fields of the stator and the rotor. Its stator winding, which consists of a 3 phase winding, is provided with a 3 phase supply, and the rotor is provided with a DC supply.</p> <p>Specifications:</p> <ul style="list-style-type: none"> • Ratings for motor operation • Class: 1.0 • Power: 0.8 kVA / 0.8 kW • Voltage: 230/400 V, Δ/Y • Current: 2.66/1.52 A • Excitation voltage: max.220 V • Excitation current: max.1.6 A • Frequency: 50 Hz • Power factor: 0.8-1-0.8 • Design: 4-pole • Speed: 1500 rpm • International protection code: IP 20 • Insulation system: B/F
Equipment Photo	
Safety Guidance	<ol style="list-style-type: none"> 1. NEVER exceed the rated maximum current and voltages. 2. NEVER turn on power before your circuit is verified by TA. 3. NEVER use an exposed wire for the connection.

Equipment Name	Three-Phase Asynchronous Motor Mod. P-4/EV
Brief Description	Use: Three-phase asynchronous motors can be considered among the most reliable electrical machines. A three-phase asynchronous motor can have - a slip-ring rotor or - a short-circuit rotor, more commonly defined squirrel-cage rotor.
	Specifications: <ul style="list-style-type: none"> • Power: 1000 W • Voltage: 230/400 V 50 Hz • R.p.m.: 2900 (2 poles) • Delta-star connection • Form of construction: IM B3 • Protection: IP 44 • This unit also includes thermal protector • Dimensions: 400 x 200 x 300 mm • Weight: 22 kg
Equipment Photo	
Safety Guidance	<ol style="list-style-type: none"> 1. NEVER exceed the rated maximum current and voltages. 2. NEVER turn on power before your circuit is verified by TA. 3. NEVER use an exposed wire for the connection.
Equipment Name	Transmission Lines Model 380 kV
Brief Description	Use: To study three-phase model of a 80 kV overhead transmission line for measuring steady-state operating conditions (no-load, matching, short-circuit)
	Specifications: <ul style="list-style-type: none"> • Quad bundle 240/40, with surge impedance 240 Ohm and natural power 600 MW length 360 km. • Tappings enable the carrying out of investigations at lengths of 144 km resp. 216 km. • Scale factor: 1/1000 for current and voltage. • Length: 360 km 216 km 144 km • Ohmic resistance: 13 Ohm 8 Ohm 5 Ohm • Inductance: 290 mH 174 mH 116 mH • Oper. capacity: 5 μF 3 μF 2 μF

Equipment Photo

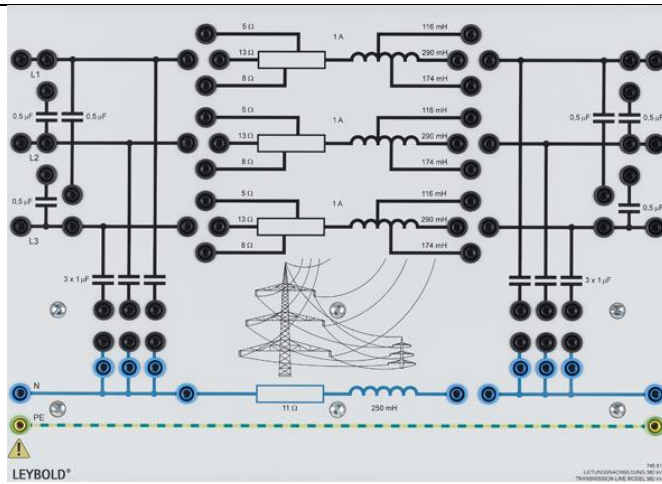

Safety Guidance

1. NEVER exceed the rated maximum current and voltages.
2. NEVER turn on power before your circuit is verified by TA.
3. NEVER use an exposed wire for the connection.

Electrical Engineering Department
Measurements and Control Lab.
Courses Related to Lab: EE 307 (Analog and Digital Measurements), EE 341 (Control Systems)

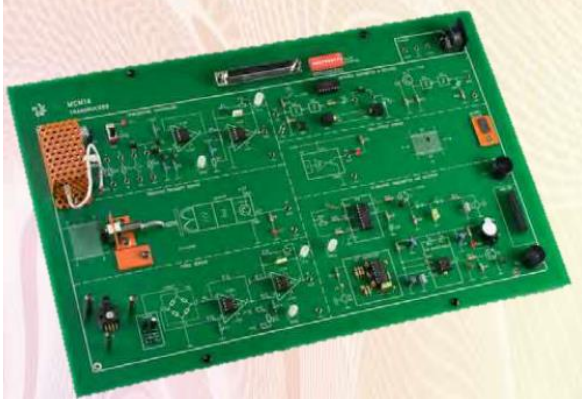
Equipment Name	Transducer Interactive Practical Electronics System Board MCM14/EV
Brief Description	<p>Use. Experiment Board for analysis of the various sensors and conditioning circuits typically used in control circuits. It contains all the pre-assembled electronic components needed to construct the experiment circuits and divided into functional circuit blocks which can be interconnected and modified by means of supplied jumpers and connection cables.</p> <p>Specifications.</p> <ul style="list-style-type: none"> • Printed circuit board with protective treatment and mimic diagram • 2 mm sockets for test points and connections • Jumpers for quick circuit modification • 37-pin connector for Interface Control Unit SIS3-U/EV • 8-pole female DIN connector for Power Supply Unit PSLC/EV • Fault simulation • Dimensions: 386 x 248 x 40 mm
Equipment Photo	
Safety Guidance	<ol style="list-style-type: none"> 1. Don't keep the heater on for long time. 2. NEVER expose to extreme heat, it affects accuracy. 3. Keep away from water. 4. NEVER connect parts wet hands, causes electric shock. 5. After use, always keep back in the case.

Equipment Name	Temperature and Light Control Interactive Practical Electronics System Board MCM 12 /EV
-----------------------	--

Brief Description	<p>Use. Temperature and Light Control Interactive Practical Electronics System Board investigates the various types of sensors and PID Control system</p>
	<p>Specifications.</p> <ul style="list-style-type: none"> • Printed circuit board with protective treatment and mimic diagram • 2 mm sockets for test points and connections • Jumpers for quick circuit modification • 37-pin connector for Interface Control Unit SIS3-U/EV • 8-pole female DIN connector for Power Supply Unit PSLC/EV • Fault simulation • Dimensions: 386 x 248 x 40 mm
Equipment Photo	
Safety Guidance	<ol style="list-style-type: none"> 1. NEVER expose to extreme heat, it affects accuracy. 2. Keep away from water. 3. NEVER connect parts wet hands, causes electric shock.

Equipment Name	Slim Power Supply Unit PSLC/EV
Brief Description	<p>Use. It supplies the necessary continuous voltages for powering the experimental modules. The voltage and current values supplied are pinpointed on the fore panel. These outputs are available on one connector set on the right bottom side of the unit. These voltages are supplied directly to the module via a cable.</p>
	<p>Specifications.</p> <ul style="list-style-type: none"> • The supplied voltages are: <ul style="list-style-type: none"> - OUTPUT 1: +1.3 Vdc ÷ +24 Vdc, 1A. Regulated voltage, electronically protected against short-circuits and overloads. Lateral knob for selecting the variable voltage. - OUTPUT 2: 24 Vac – 0 – 24 Vac, 0.5A. Protected with fuse. - OUTPUT 3: +5 Vdc – 2 A. - OUTPUT 4: +12 Vdc – 2 A. Regulated voltage, electronically protected against short-circuits and overloads. - OUTPUT 5: -12 Vdc – 1A. Regulated voltage, electronically protected against short-circuits and overloads. • Power supply: 230 Vac 50 Hz single-phase - 130 VA

	<ul style="list-style-type: none"> • Dimensions: 385 x 105 x 130 mm • Weight: 5 kg
<p>Equipment Photo</p>	
<p>Safety Guidance</p>	<ol style="list-style-type: none"> 1. NEVER expose to extreme heat, it affects accuracy. 2. NEVER connect parts wet hands, causes electric shock.

Communication Principles Lab EE 323	
Courses Related to Lab: Fundamentals of Electrical Circuits EE 322	
Equipment Name	53-230-USB, training Kit , Modulation and Coding Principles
Brief Description	<p>Use: This modern training system provides a learning platform that involves the interaction between hardware, software, PC and the student. It has been specifically developed to convey the theory of a wide variety of subjects in a way that enhances the learning experience through visual presentation and interaction with the subject matter. The Modulation and Coding Principles workboard covers the principles and practice of many of the modulation and demodulation formats used in modern analogue and digital communication systems. Many individual circuits are provided that are studied individually and collectively by interconnecting the various circuits together. The workboard is connected to a PC via a USB Real-time Access Terminal (92-203 RAT). The Terminal also provides all the necessary power supplies for the workboard to operate. Integrated with the hardware is a comprehensive laboratory software package comprising full student instruction for performing the many assignments and practical activities, together with relevant background and theoretical information.</p> <p>Specifications:</p> <ul style="list-style-type: none"> • The instruments provided are: • 2-channel oscilloscope • Spectrum Analyser • Phase scope with phasor (vector) display • Constellation display • Frequency meter • Voltmeter
Equipment Photo	
Safety Guidance	<ol style="list-style-type: none"> 1. Avoid water near the device. 2. NEVER expose to extreme heat, it affects accuracy. 3. NEVER connect parts wet hands, causes electric shock. 4. After using, the box of the kit should be closed
Electrical Engineering Department	
Microprocessor Lab EE 361	
Courses Related to Lab: EE 360 (Microprocessor)	

Equipment Name	MIDAS 8086 Microprocessor Kit	
Brief Description	<p>Use. To perform the experiments of microprocessor 8086 with the help of WinIDE8086 software.</p>	
	<p>Specifications.</p> <ul style="list-style-type: none"> • CPU 8086, Main RAM 64KB(62256 x 2), Monitor ROM 64KB(27256 x 2), Display Unit LCD (16 X 2 Line) • I/O Port 8255A Serial Port RS-232C (8251A) • System Clock 14.7456MHz Clock Generator 8254 (Clock Generator) • Interrupt Controller 8259, Timer Controller 8253 • Level Meter HG101A, Dot Matrix 8 X 8 (2 color) • Software 8086 Assembler • Support C-Language example code • MDA-WinIDE8086 Integration Development Program • Key Board 16 Hexadecimal and 10 function keys • System BUS indicator LED X 12 • Extended Connector System BUS : 62 pins • External interface : 20 pins • Stepper motor interface Driver T.R X 4 • A/D, D/A Converter ADC : ADC0804, DAC : DAC0800 • Power - Input : AC 85 ~ 264V, Output : DC +5V(2A), +12V(1A), -12V(500mA) • Board size 310 x 265 mm, Aluminum case size 140(H) x 320(D) x 400(W)mm, Weight 4 kg 	
Equipment Photo		
Safety Guidance	<ol style="list-style-type: none"> 1. Avoid water near the device. 2. NEVER expose to extreme heat, it affects accuracy. 3. NEVER connect parts wet hands, causes electric shock. 4. After using, the box of the kit should be closed 	

Electrical Engineering Department

Electric Power and Machine Lab 2 EE 373

Equipment Name	Single-Phase Transformer Mod. P-13/EV
Brief Description	<p>Use: To recognize the construction, different parts, terminals and ratings of the single phase transformer, to carry out the necessary tests to determine the parameters of the equivalent circuit and performance characteristics of the single phase transformer.</p> <p>Specifications:</p> <ul style="list-style-type: none"> • Power: 1000 VA • Voltage of primary winding: 230 V 50 Hz • Voltage of secondary winding 1: 0-53-200-400V • Voltage of secondary winding 2: 0-115-230 V • Protection: IP 22 • This unit also includes thermal protector • Dimensions: 360 x 200 x 300 mm • Weight: 21 kg
Equipment Photo	
Safety Guidance	<ol style="list-style-type: none"> 1. NEVER exceed the rated maximum current and voltages. 2. NEVER use short circuit test for more than few seconds 3. NEVER turn on power before your circuit is verified by TA. 4. NEVER use an exposed wire for the connection.

Equipment Name	Three-Phase Transformer Mod. P-14/EV
Brief Description	<p>Use: To recognize the construction, different parts, terminals and ratings of the three phase transformer, to carry out the necessary tests to determine the parameters of the equivalent circuit and performance characteristics of the three phase transformer.</p> <p>Specifications:</p> <ul style="list-style-type: none"> • Power: 1000 VA • Voltage of primary winding: 230/400/346V 50 Hz (*) • Delta/star/zigzag connection • Voltage of secondary winding: 230/400/346V (*) • Delta/star/zigzag connection • Protection: IP 22 • This unit also includes thermal protector • Dimensions: 360 x 200 x 300 mm

	<ul style="list-style-type: none"> Weight: 27 kg
Equipment Photo	
Safety Guidance	<ol style="list-style-type: none"> NEVER exceed the rated maximum current and voltages. NEVER use short circuit test for more than few seconds NEVER turn on power before your circuit is verified by TA. NEVER use an exposed wire for the connection.

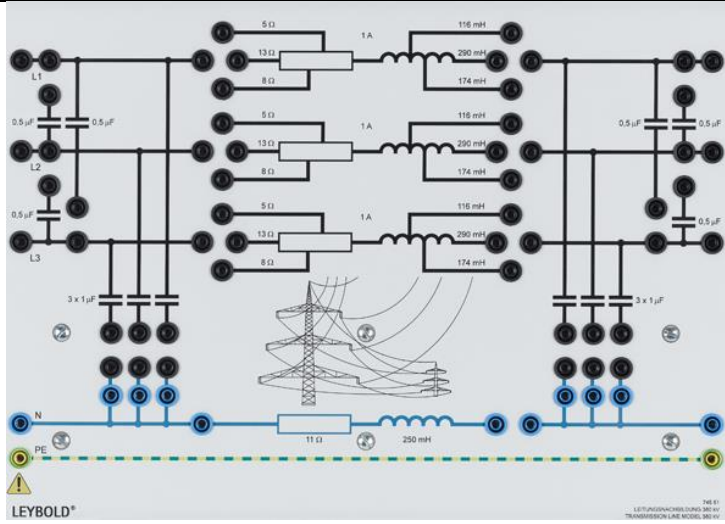
Equipment Name	Transmission Lines Model 380 kV
Brief Description	<p>Use: To study three-phase model of a 80 kV overhead transmission line for measuring steady-state operating conditions (no-load, matching, short-circuit)</p> <p>Specifications:</p> <ul style="list-style-type: none"> Quad bundle 240/40, with surge impedance 240 Ohm and natural power 600 MW length 360 km. Tappings enable the carrying out of investigations at lengths of 144 km resp. 216 km. Scale factor: 1/1000 for current and voltage. Length: 360 km 216 km 144 km Ohmic resistance: 13 Ohm 8 Ohm 5 Ohm Inductance: 290 mH 174 mH 116 mH Oper. capacity: 5 μF 3 μF 2 μF
Equipment Photo	
Safety Guidance	<ol style="list-style-type: none"> NEVER exceed the rated maximum current and voltages. NEVER use short circuit test for more than few seconds NEVER turn on power before your circuit is verified by TA. NEVER use an exposed wire for the connection.

Equipment Name	Direct-Current Motor /Generator With Separate / Compound Excitation Mod. P-1/EV
Brief Description	<p>Use: To recognize the construction, different parts, and rating of the separately excited DC motor, determine the performance characteristics of DC motor</p> <p>Specifications:</p> <ul style="list-style-type: none"> • Power: 1000 W • Armature voltage: 220 Vdc • Excitation voltage: 220 Vdc • Rpm.: 3000 • It also operates as DC motor • Form of construction: IM B3 • Protection: IP 22 • This unit also includes thermal protector • Dimensions: 500 x 200 x 300 mm • Weight: 48 kg
Equipment Photo	
Safety Guidance	<ol style="list-style-type: none"> 1. NEVER exceed the rated maximum current and voltages. 2. NEVER use short circuit test for more than few seconds 3. NEVER turn on power before your circuit is verified by TA. 4. NEVER use an exposed wire for the connection.

Equipment Name	Tabletop Power Supply Unit For Electric Measurements And Machines
Brief Description	<p>Use: To implement the experimental programs of general electric measurements and of measurements applied to electric machines.</p> <p>Specifications:</p> <ul style="list-style-type: none"> • Main control device 3 x 400 V / N / PE, 50-60 Hz, absorption 6 kVA • Service line with three-phase and single-phase socket • Fixed line of 220 Vdc – 20 A, • Variable three-phase line with neutral conductor of 0-430 Vac 8 A / 0-500 Vdc 8 A • Dimensions: 600 x 500 x 500 mm • Net weight: 50 kg

Equipment Photo	
Safety Guidance	<ol style="list-style-type: none"> 1. Follow the proper switching on and off procedure 2. Press Emergency push button for any emergency 3. NEVER turn on power before your circuit is verified by TA. 4. NEVER use an exposed wire for the connection.

Equipment Name	Three-phase Synchronous Motor
Brief Description	<p>Use: The operation of a synchronous motor is due to the interaction of the magnetic fields of the stator and the rotor. Its stator winding, which consists of a 3 phase winding, is provided with a 3 phase supply, and the rotor is provided with a DC supply.</p> <p>Specifications:</p> <ul style="list-style-type: none"> • Ratings for motor operation • Class: 1.0 • Power: 0.8 kVA / 0.8 kW • Voltage: 230/400 V, Δ/Y • Current: 2.66/1.52 A • Excitation voltage: max.220 V • Excitation current: max.1.6 A • Frequency: 50 Hz • Power factor: 0.8-1-0.8 • Design: 4-pole • Speed: 1500 rpm • International protection code: IP 20 • Insulation system: B/F

Equipment Photo	
Safety Guidance	<ol style="list-style-type: none"> 1. NEVER exceed the rated maximum current and voltages. 2. NEVER turn on power before your circuit is verified by TA. 3. NEVER use an exposed wire for the connection.

Equipment Name	Three-Phase Asynchronous Cage Motor Mod. P-4/EV
Brief Description	<p>Use: Three-phase asynchronous motors can be considered among the most reliable electrical machines. A three-phase asynchronous motor can have - a slip-ring rotor or - a short-circuit rotor, more commonly defined squirrel-cage rotor.</p> <p>Specifications:</p> <ul style="list-style-type: none"> • Power: 1000 W • Voltage: 230/400 V 50 Hz • R.p.m.: 2900 (2 poles) • Delta-star connection • Form of construction: IM B3 • Protection: IP 44 • This unit also includes thermal protector • Dimensions: 400 x 200 x 300 mm • Weight: 22 kg
Equipment Photo	
Safety Guidance	<ol style="list-style-type: none"> 1. NEVER exceed the rated maximum current and voltages. 2. NEVER turn on power before your circuit is verified by TA. 3. NEVER use an exposed wire for the connection.

Electrical Engineering Department
Protection and High Voltage Lab EE 479
Courses Related to Lab: EE 476, EE 477

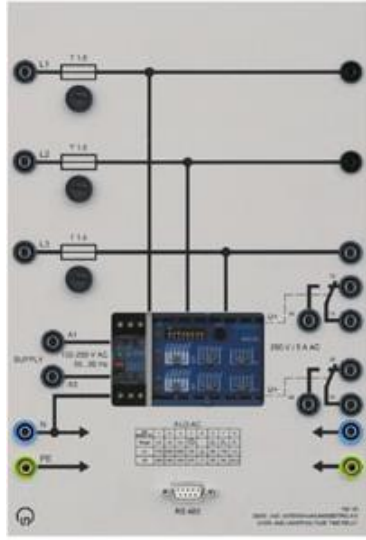
Equipment Name	3~ Time Over/ UnderVoltage relay Leybold 745 181
Brief Description	<p>Use: Digital measuring relay for the supervision of 2-, 3- and 4-leading nets on inadmissible about or under voltages (earth fault) with phases result supervision (ANSI 27 and 59).</p> <p>Specifications:</p> <ul style="list-style-type: none"> • Nominal voltage V_n: 100,110, 230, 400 V AC (Line-to-line) • Nominal frequency f_N: 35 – 66 Hz • Auxiliary voltage V_V: 36-520 V AC ($f = 35-78$ Hz) or 50-750 V DC/ 4 W
Equipment Photo	
Safety Guidance	<ol style="list-style-type: none"> 1. NEVER exceed the rated maximum current and voltages. 2. NEVER turn on power before your circuit is verified by TA. 3. NEVER use an exposed wire for the connection.

Equipment Name	Power Circuit Breaker Leybold 745 561
Brief Description	<p>Use: 3-phase ON/OFF switch with auxiliary contact (NC) for 380 kV transmission line model. Can be controlled manually using ON/OFF push-button or externally via switching contact, TTL level or 24 V DC. The switching state is indicated by LED's and is additionally available as TTL level from 4-mm sockets. Control input (switching contact, TTL level, 24 V DC) for external switch-off command (tripping on faults).</p> <p>Specifications:</p> <ul style="list-style-type: none"> • Contact load capacity: 400 V AC, 3 A • Mains connection: 115/230 V, 50 Hz

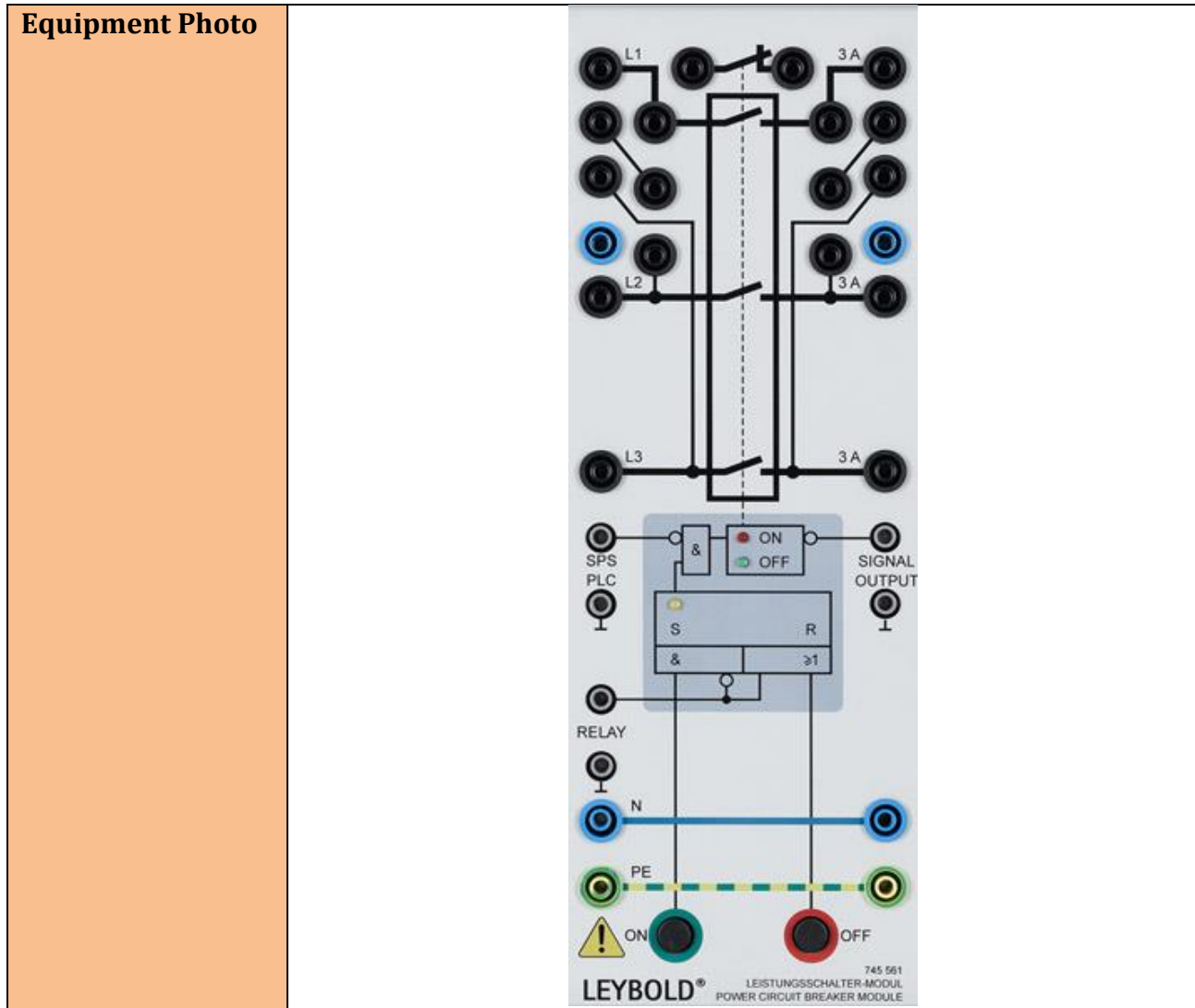

<p>Safety Guidance</p>	<ol style="list-style-type: none"> 1. NEVER exceed the rated maximum current and voltages. 2. NEVER turn on power before your circuit is verified by TA. 3. NEVER use an exposed wire for the connection.
-------------------------------	--

<p>Equipment Name</p>	<p>Three-Phase Transformer TL380KV Leybold 745 50</p>
<p>Brief Description</p>	<p>Use: Transformer for feeding the transmission line model 380 kV. Scale factor 1:1000 for secondary current and voltage.</p> <p>Specifications:</p> <ul style="list-style-type: none"> • Rated power: 800 VA • Primary: <ul style="list-style-type: none"> - 3 x 400 V winding with tapping at 230 V - can be switched to star or delta connection • Delta stabilizing winding can be connected. • Secondary: <ul style="list-style-type: none"> - 3 x 380 V winding with tapings at • + 5 %, - 5 %, - 10 %, - 15 % <ul style="list-style-type: none"> - in star connection, various star • point connections possible

<p>Equipment Photo</p>	
<p>Safety Guidance</p>	<ol style="list-style-type: none"> 1. NEVER exceed the rated maximum current and voltages. 2. NEVER turn on power before your circuit is verified by TA. 3. NEVER use an exposed wire for the connection.

<p>Equipment Name</p>	<p>Three-phase supply unit with ELCB Leybold 726 75</p>
<p>Brief Description</p>	<p>Use: To switch the 3-phase supply in experiments with electrical loads for line voltages of 400 V.</p> <p>Specifications:</p> <ul style="list-style-type: none"> • Cam switch, 4 pole • Earth-leakage circuit breaker, 30 mA • Motor protection switch, 6-10 A • Phase indicator lamps L1, L2, L3
<p>Equipment Photo</p>	
<p>Safety Guidance</p>	<ol style="list-style-type: none"> 1. NEVER exceed the rated maximum current and voltages. 2. NEVER turn on power before your circuit is verified by TA. 3. NEVER use an exposed wire for the connection.

Equipment Name Brief Description	3~ Time overcurrent relay (I)DMT Leybold 745 2311 Use: Universal time overcurrent relay to the selective capture of overloading and short circuits (ANSI 50 and 51). Configurable as independent time overcurrent protection (IDMT) or dependent time overcurrent (DMT) with different release characteristics. With RS485 interface. Specifications: <ul style="list-style-type: none"> Nominal frequency f_n: 50/60 Hz. Nominal auxiliary voltage V_v: 19-390 V DC or 36-275 V AC ($f = 40-70$ Hz)/4 W.
Equipment Photo	
Safety Guidance	<ol style="list-style-type: none"> NEVER exceed the rated maximum current and voltages. NEVER turn on power before your circuit is verified by TA. NEVER use an exposed wire for the connection.

Equipment Name	Resistive load 1.0 Leybold 733 10
Brief Description	Use:

	<p>Three synchronously adjustable circular rheostats (step winding) with scale (100 - 0%), each with a series resistor and fuse in the sliding-contact connection, suitable for parallel, series, star and delta circuits.</p> <p>Specifications:</p> <ul style="list-style-type: none"> • Resistance: 3 x 1000 Ω • Series resistance: 3 x 22 Ω • Current: 3 x 2.5 A
<p>Equipment Photo</p>	
<p>Safety Guidance</p>	<ol style="list-style-type: none"> 1. NEVER exceed the rated maximum current and voltages. 2. NEVER turn on power before your circuit is verified by TA. 3. NEVER use an exposed wire for the connection.

<p>Equipment Name</p>	<p>Double Busbar Leybold 745 652</p>
<p>Brief Description</p>	<p>Use:</p>

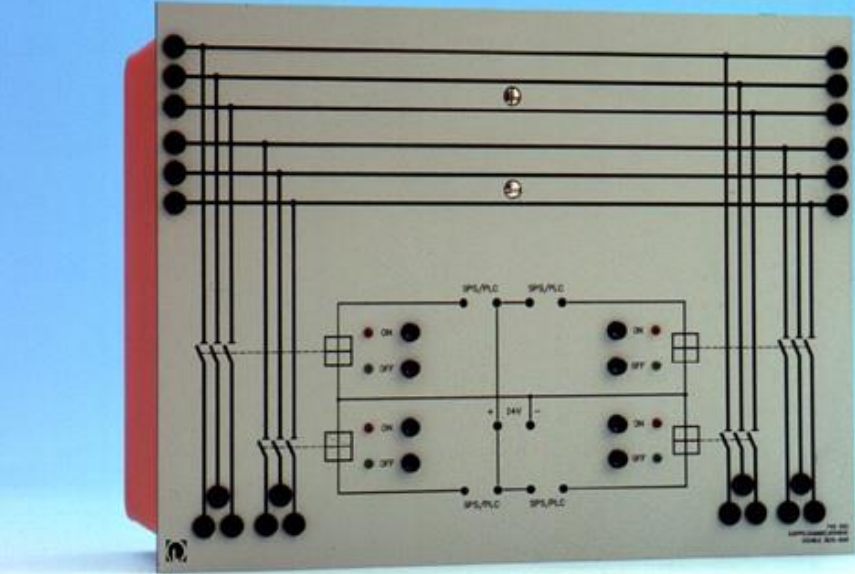
	<p>Two three-phase busbars, each with two branches containing disconnectors, can be controlled manually using the ON/OFF pushbutton or externally via a switching contact, TTL-level or 24 V DC.</p> <p>Specifications:</p> <ul style="list-style-type: none"> • The switching state is indicated by LED's • Acoustic warning tone when switching is carried out under load • Supply voltage: 24 V DC
<p>Equipment Photo</p>	
<p>Safety Guidance</p>	<ol style="list-style-type: none"> 1. NEVER exceed the rated maximum current and voltages. 2. NEVER turn on power before your circuit is verified by TA. 3. NEVER use an exposed wire for the connection.

<p>Equipment Name</p>	<p>Double Busbar Extension Leybold 745 654</p>
<p>Brief Description</p>	<p>Use: Two three-phase busbars, each with one branch containing disconnector, can be controlled manually using the ON/OFF pushbutton or externally via a switching contact, TTL-level or 24 V DC.</p> <p>Specifications:</p> <ul style="list-style-type: none"> • The switching state is indicated by LED's • Acoustic warning tone when switching is carried out under load • Supply voltage: 24 V DC

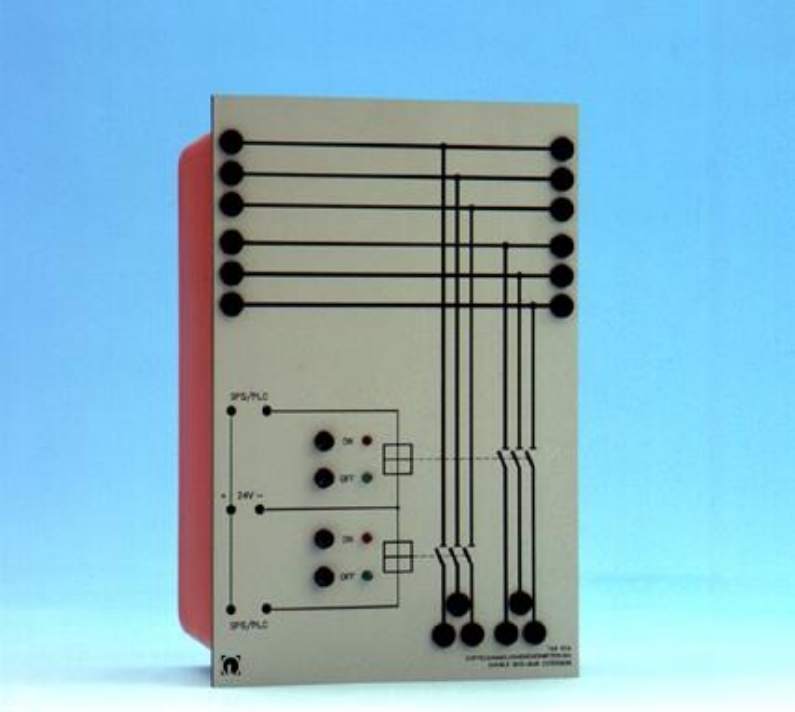
Equipment Photo	
Safety Guidance	<ol style="list-style-type: none"> 1. NEVER exceed the rated maximum current and voltages. 2. NEVER turn on power before your circuit is verified by TA. 3. NEVER use an exposed wire for the connection.

Equipment Name	Multifunctional measuring instrument PX 120
Brief Description	<p>Use: For the measurement of voltage, current, active power, reactive and apparent power, power factor. Also, measurement of RMS values in AC and DC (TRMS), enables the measurements in the four quadrants on signals which are disturbed and polluted by waves.</p> <p>Specifications:</p> <ul style="list-style-type: none"> • Active power: 10 W - 1 kW, 1 kW - 6 kW • Reactive and apparent power: 10 - 1 kVA(var), 1 kVA(var) - 6 kVA(var) • Power factor: 0.00 - 1.00 • Voltage: 0.5 - 600 V rms • Input impedance: 1 MOhm • Current: 10 mA - 2 A, 2 A - 10 A rms • Starting current: 5 A - 65 A (peak) • Power supply: 6 x 1.5 V battery (LR 6) • Operation time: 40 hours • Safety standard: IEC 61010-1, Cat. III, 600 V.

Equipment Photo	
Safety Guidance	<ol style="list-style-type: none"> 1. NEVER exceed the rated maximum current and voltages. 2. NEVER turn on power before your circuit is verified by TA. 3. NEVER use an exposed wire for the connection.

Equipment Name	Multi-functional meter Leybold 727 230
Brief Description	<p>Use: The multi-functional meter is an all-purpose electronic meter for the measurement and monitoring of all important parameters for three-phase mains. The LC display with background lighting allows for reliable readings with no glare to be made even from long distance. A clear user interface and direct display of the functions used for all measurements are characteristic of the instrument. With integrated active and reactive power meters.</p> <p>Specifications:</p> <ul style="list-style-type: none"> • USB interface • Compatible with CASSY Lab 524220 software for recording and evaluation of measured data • Integrated kWh active power meter, kWh reactive energy meter and counter for operating time in hours • Min/max memory for all relevant measured values • Simultaneous display of 3 measuring values and energy operating hours • Display of the mean current and of the mean maximum current (bimetallic/friction pointer function) • Selectable integration time • All measuring values with direct dimension display • Two overload outputs or freely selectable • One pulse output/one overload output • Overload monitoring functions of all measuring values, freely selectable pulse output for active power • Analogue output 0/4-20 mA or 0/2-10 V • Direct input, 3 x 30 A AC • Mains connection 230 V AC • Measurement quantities • Voltage: V, Vmin, VL-N, VL-L 3 x 23...475 V AC

	<ul style="list-style-type: none"> • Current: I, I_{mean}, I_{max}, I_{L1}/I_{L2}/I_{L3} up to 3 x 10 A AC • Active power: P, P_{mean}, P_{max}, P_S/P_{L1}/P_{L2}/P_{L3} • Reactive power: Q, Q_{mean}, Q_{max}, Q_S/Q_{L1}/Q_{L2}/Q_{L3} • Power factor $\cos \varphi$, $\cos \varphi_S$/$\cos \varphi_{L1}$/$\cos \varphi_{L2}$/$\cos \varphi_{L3}$ • Mains frequency: f_{mains}, f_{L1}/f_{L2}/f_{L3} 45...65 Hz • Accuracy: 1% of maximum value in measuring range
Equipment Photo	
Safety Guidance	<ol style="list-style-type: none"> 1. NEVER exceed the rated maximum current and voltages. 2. NEVER turn on power before your circuit is verified by TA. 3. NEVER use an exposed wire for the connection.

Equipment Name	3~ Reverse power relay Leybold 745 201
Brief Description	<p>Use: Digital measuring relay for the collection of the active power delivered by reverse powers with direction recognition with aggregates in the parallel operation and for the monitoring of generators (ANSI 32 and 37). With RS485-interface.</p> <p>Specifications:</p> <ul style="list-style-type: none"> • Nominal voltage V_n: 100,110, 230, 400 V AC (Line-to-line) • Nominal frequency: 35 - 74 Hz • Auxiliary voltage V_V: 36-520 V AC (f = 35-78 Hz) or 50-750 V DC/4 W

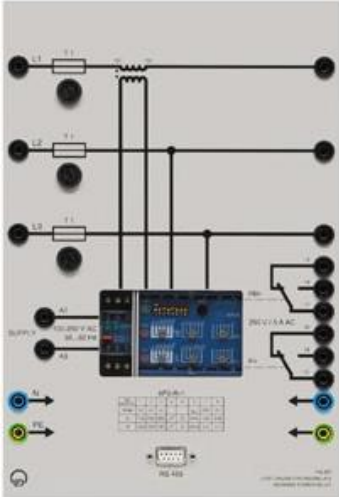
Equipment Photo	
Safety Guidance	<ol style="list-style-type: none"> 1. NEVER exceed the rated maximum current and voltages. 2. NEVER turn on power before your circuit is verified by TA. 3. NEVER use an exposed wire for the connection.

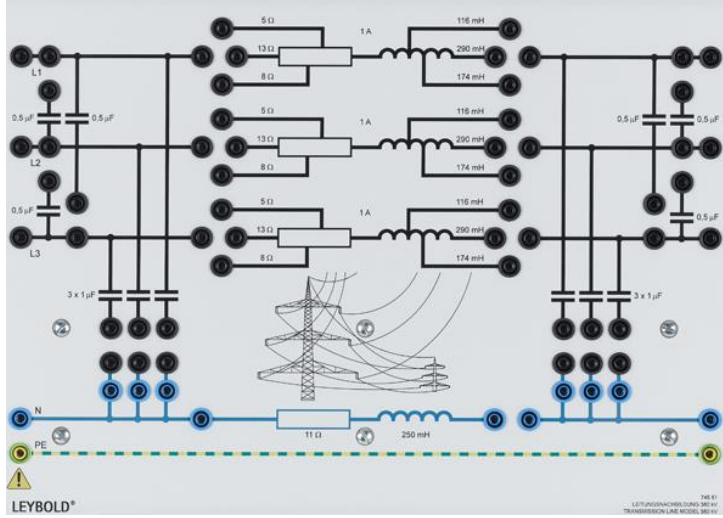
Equipment Name	Transmission Lines Model 380 kV Leybold 745 51N
Brief Description	<p>Use: To study three-phase model of a 80 kV overhead transmission line for measuring steady-state operating conditions (no-load, matching, short-circuit)</p> <p>Specifications:</p> <ul style="list-style-type: none"> • Quad bundle 240/40, with surge impedance 240 Ohm and natural power 600 MW length 360 km. • Tappings enable the carrying out of investigations at lengths of 144 km resp. 216 km. • Scale factor: 1/1000 for current and voltage. • Length: 360 km 216 km 144 km • Ohmic resistance: 13 Ohm 8 Ohm 5 Ohm • Inductance: 290 mH 174 mH 116 mH • Oper. capacity: 5 μF 3 μF 2 μF
Equipment Photo	
Safety Guidance	<ul style="list-style-type: none"> • NEVER exceed the rated maximum current and voltages. • NEVER use short circuit test for more than few seconds • NEVER turn on power before your circuit is verified by TA. • NEVER use an exposed wire for the connection.

Equipment Name	3~ Directional Earth Fault Relay Leybold 745 2921
Brief Description	Use: Digital earth fault protection relay for systems with isolated or counteracted star point to the direction-selective capture of accidental earths (ANSI 50N, 51N and 67N). With RS485 interface.
	Specifications: <ul style="list-style-type: none"> • Nominal voltage VN : 100 V, 230 V, 400 V • Nominal frequency fN : 50/60 Hz • Auxiliary voltage: 16 - 360 V DC/16 - 270 V AC
Equipment Photo	
Safety Guidance	<ol style="list-style-type: none"> 1. NEVER exceed the rated maximum current and voltages. 2. NEVER turn on power before your circuit is verified by TA. 3. NEVER use an exposed wire for the connection.

Equipment Name	Transformer Differential Protective Relay Leybold 745 331
Brief Description	Use: Industrial protective relay for the monitoring of the transformer (745 50) according to the principle of the differential protection. The relay measures the input and output currents of the transformer using an internal matching converter and trips when short-circuits occur between the turns and the windings as well as for earth faults. The display of the operating state and the tripping is carried out using LEDs.
	Specifications: <ul style="list-style-type: none"> • Rated current: 1 A • Rated frequency: 50...60 Hz • Auxiliary voltage: 36...275 V AC or 19...390 V DC • Output contact: 1 x CO

Equipment Photo

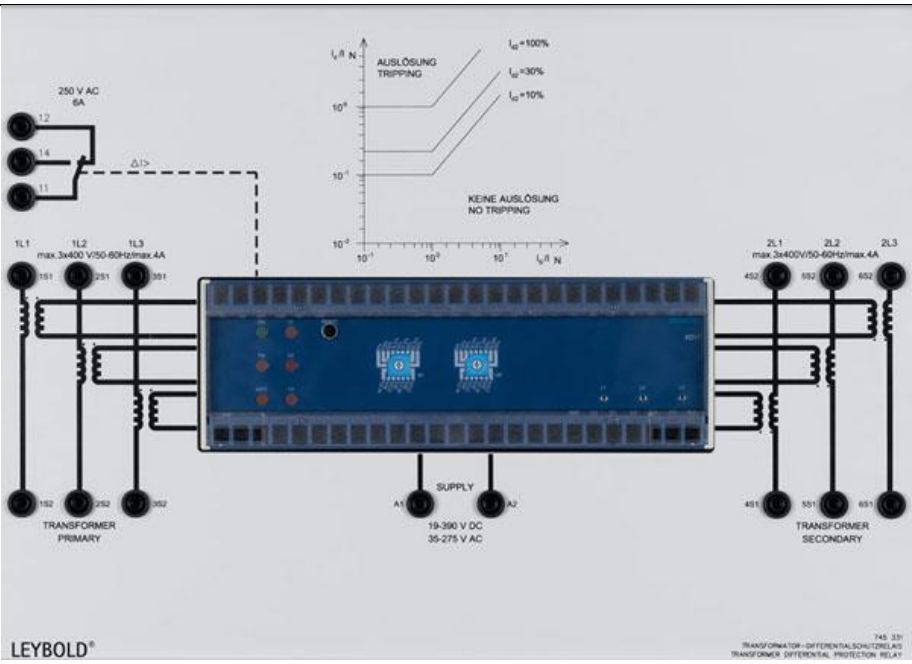

Safety Guidance

1. NEVER exceed the rated maximum current and voltages.
2. NEVER turn on power before your circuit is verified by TA.
3. NEVER use an exposed wire for the connection.

Equipment Name **Reactive Power Controller Leybold 745 0911**

Brief Description

Use:
Electronic VAR controller with $\cos \varphi$ display for automatic switching of Compensation capacitors in systems with inductive load.

- Specifications:**
- Compensation range: 0.8 ind...1...0.8 cap
 - Operating sensitivity: 0.4...0.9 C/K
 - $\cos \varphi$ display: 0.8 ind...1...0.88 cap
 - Switch manual/automatic
 - Number of switching levels: 4
 - Output contacts: 4 NO, each 250 V AC, 4 A
 - Illuminated graphic arts display
 - Supply voltage: 3 x 380...415 V, 50/60 Hz

<p>Equipment Photo</p>	
<p>Safety Guidance</p>	<ol style="list-style-type: none"> 1. NEVER exceed the rated maximum current and voltages. 2. NEVER turn on power before your circuit is verified by TA. 3. NEVER use an exposed wire for the connection.

<p>Equipment Name</p>	<p>Switchable Capacitor Battery Leybold 745 095</p>
<p>Brief Description</p>	<p>Use: System, with which different capacitance values can be connected to the mains for reactive power compensation. The capacitor battery contains 4 switching levels which can be connected and disconnected using power contactors. Each switching level can be controlled separately, internally or externally. The switching levels each consist of 3 capacitors in star connection with discharging resistors.</p> <p>Specifications:</p> <ul style="list-style-type: none"> • Switching level 1: 3 x 2 μF, 450 V, 50 Hz • Switching level 2: 3 x 4 μF, 450 V, 50 Hz • Switching level 3: 3 x 8 μF, 400 V, 50 Hz • Switching level 4: 3 x 16 μF, 400 V, 50 Hz • Compensation power: max. 1368 VAR

Equipment Photo	
Safety Guidance	<ol style="list-style-type: none"> 1. NEVER exceed the rated maximum current and voltages. 2. NEVER turn on power before your circuit is verified by TA. 3. NEVER use an exposed wire for the connection.

Equipment Name	Summation Current Transformer Leybold 745 30	
Brief Description	<p>Use: Suitable for earth fault detection, for current determination with differential protection and for the summation of in-phase currents in different sub-networks when measuring single-phase power or current.</p> <p>Specifications:</p> <ul style="list-style-type: none"> • Primary: 5 x 2.5 A • Secondary: 1 A • Power: 10 VA • Class: 1 	
Equipment Photo		
Safety Guidance	<ol style="list-style-type: none"> 1. NEVER exceed the rated maximum current and voltages. 2. NEVER turn on power before your circuit is verified by TA. 3. NEVER use an exposed wire for the connection. 	

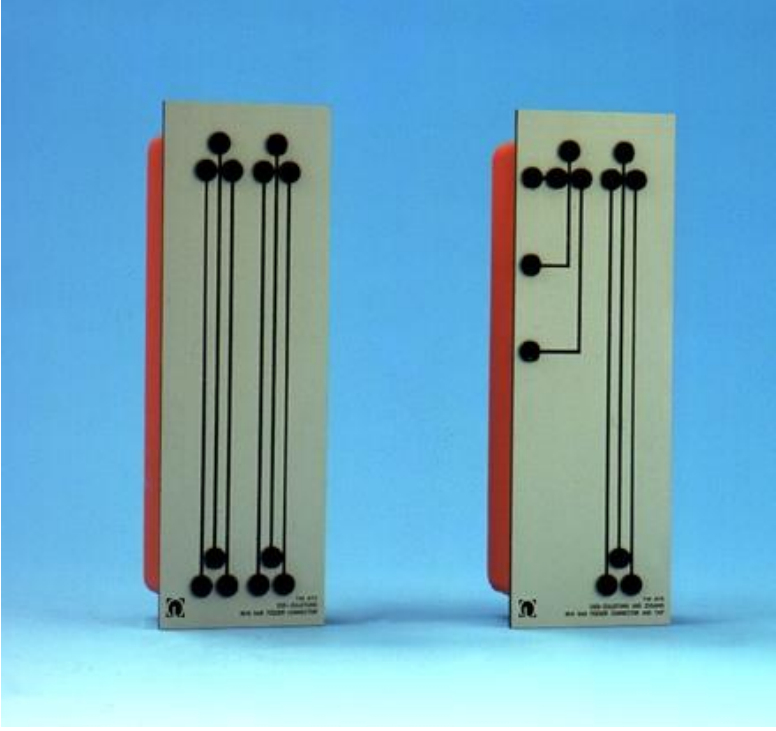
Equipment Name	Double Busbar Feeder Connector Leybold 745 673
Brief Description	Use: Two three-phase lines for connecting a load to the double busbar
	Specifications: <ul style="list-style-type: none"> • Class: 1
Equipment Photo	
Safety Guidance	<ol style="list-style-type: none"> 1. NEVER exceed the rated maximum current and voltages. 2. NEVER turn on power before your circuit is verified by TA. 3. NEVER use an exposed wire for the connection.

Electrical Engineering Department
Electronics Workshop

Courses Related to Lab: EE498 & EE499

Equipment Name	Digital Oscilloscope TBS 1102
Brief Description	Use. To display, analyze and store the waveform digitally
	Specifications. <ul style="list-style-type: none"> • 200 MHz, 150 MHz, 100 MHz, 70 MHz, 50 MHz, 30 MHz bandwidth models • 2 channel models • Up to 2 GS/s sample rate on all channels • 2.5k point record length on all channels • Advanced triggers including pulse and line
Equipment Photo	
Safety Guidance	<ol style="list-style-type: none"> 1. Do not operate the oscilloscope with the case removed 2. Use only 3-wire outlet 3. Excessive voltage applied to the input jacks may damage the oscilloscope. 4. Never obstruct the ventilating holes. 5. Never allow a small spot of high brilliance to remain stationary on the screen for more than few seconds.

Equipment Name	Function generator FG-52
Brief Description	Use. Generate different type of electric waveform over a wide range of frequencies.
	Specifications. <ul style="list-style-type: none"> • Frequency: 0.05Hz ~ 5MHz display by 5 digits LED, Max. resolution 0.001Hz in 8 ranges. Wave form output : Sine, Square, Triangle, Positive , Ramp, Negative Ramp, Positive Pulse and Negative Pulse, DC 8 wave forms. • Stability: 0.1% ~15 minutes after switch "ON", 0.2% ~ 24hrs after switch "ON". • DC offset : +/- 10V(No. Load), +/- 5V(50Ω Load), continuous adjustable, controlled by a offset switch. • Counter - • Display: 5 digits 0.36" red LED. Max. Resolution - 0.001HZ. • Display unit : Hz / KHz Automatically controlled by CPU.

Equipment Photo	
Safety Guidance	<ol style="list-style-type: none"> 1. Never place heavy objects on the instrument. 2. Never place a hot soldering iron on or near the instrument. 3. Never insert wires, pins or other metal objects into ventilation fan. 4. Never move or pull the instrument with power cord or probe cord. 5. Especially never move instrument when power cord or signal probe is connected to a circuit. 6. 5. If the instrument is used in a manner not specified by the manufacturer, the protection provided by the equipment may be impaired.

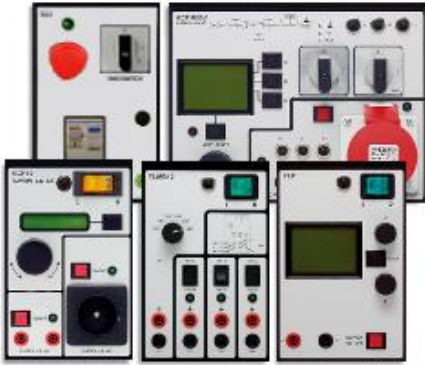
Equipment Name	AC and DC Power Supply ACP 40: 0-250VAV/ 0-4A, TLMB12
Brief Description	<p>Use. Programmable AC power supply, Fixed DC Power Supply.</p> <p>Specifications.</p> <ul style="list-style-type: none"> • 0-250VAV/ 0-4A
Equipment Photo	
Safety Guidance	<ul style="list-style-type: none"> • Excessive voltage applied to the input jacks may damage the function generator. • NEVER obstruct the ventilating holes. • Use only 3-wire outlet • Do not use power supply in a place where ambient temperature exceed 40°C • 5. Operate the machine only with approved accessories

Equipment Name	Digital Multimeter Fluke 179
Brief Description	<p>Use. It combines several measurement functions in one unit.</p>

	<p>Specifications.</p> <ul style="list-style-type: none"> • DC mV 0.1 mV to 600 mV. • Temperature -40 °C to +400 °C. -40 °F to +752 °F. • Beeper turns on at <25 Ω and turns off at >250 Ω. • Diode test. Displays above 2.4 V. • AC A from 0.300 A to 10 A. • DC A from 0.001 A to 10 A. • >10.00, display flashes. • >20 A, ∞ is displayed. • Frequency of ac A 2 Hz to 30 kHz. • Ohms from 0.1 Ω to 50 MΩ. • Farads from 1 nF to 9999 μF. • AC mA from 3.00 mA to 400 mA. • DC mA from 0.01 mA to 400 mA. • Frequency of ac mA 2 Hz to 30 kHz
<p>Equipment Photo</p>	
<p>Safety Guidance</p>	<ol style="list-style-type: none"> 1. To prevent damage or injury install Quick acting fuses with standard AMP/VOLT rating 2. Do not use the Product if it is damaged. 3. Do not use the Product if it operates incorrectly. 4. Only use probes, test leads, and accessories that have the same measurement category, voltage, and amperage ratings as the Product. 5. Remove the batteries if the Product is not used for an extended period of time, or if stored in temperatures above 50 °C. If the batteries are not removed, battery leakage can damage the Product.

<p>Equipment Name</p>	<p>Soldering/ De-soldering Station LF-8000</p>
<p>Brief Description</p>	<p>Use: Soldering and de-soldering of electronic components.</p>

	<p>Specifications:</p> <ul style="list-style-type: none"> • Soldering Iron: • Heater operation voltage 32Vac • Heater power consumption 100W (50Wx2) • Temperature range 150-430°C • Standard tip 46-060102 • Desoldering Iron: • Heater operation voltage 32Vac • Heater power consumption 80W • Temperature range 300-450°C • Standard tip 44-915412-2075
<p>Equipment Photo</p>	
<p>Safety Guidance</p>	<ol style="list-style-type: none"> 1. Never touch the element of the soldering iron....400°C 2. Hold the wire to be heated with tweezers or clamp 3. Keep the cleaning sponge wet during use 4. Always return the soldering iron to its stand when not in use. Never put down on workbench 5. Turn unit off and unplug when not in use 6. Wear eye protection. Solder can spit 7. Use rosin and lead free solder wherever possible 8. Keep cleaning solvent in dispensing bottles 9. Always wash your hand with soap and water after soldering 10. Fume extraction should be through an enclosed hood or tip extraction

<p>Equipment Name</p>	<p>Board Plotter PCB Machine ProtoMat S-42</p>
<p>Brief Description</p>	<p>Use: Precision PCB Prototypes.</p>

	<p>Specifications:</p> <ul style="list-style-type: none"> • Working area 229 mm x 305 mm • Resolution 7.5 µm • Milling motor speed 42000 rpm • Tool change Manual • Tool collect 3.175 mm • Drilling speed 90 holes per minute • Travel speed 500 mm/sec • X / Y motion 2 phase stepper motor • Z drive Solenoid • Dimensions 580 mm x 480 mm x 620 mm • Weight 43 Kg • Power supply 120/240 V 60 Hz • Hardware and Software Microsoft Windows 2000 / XP
<p>Equipment Photo</p>	
<p>Safety Guidance</p>	<ol style="list-style-type: none"> 1. Never operate the machine in environments subject to fire or explosion hazards 2. Protect the machine against direct sunlight, humidity and flying sparks 3. Operate the machine only with accessories approved by LPKF and original LPKF tools 4. Use the machine only in perfect condition. Prior to each use, perform a visual inspection. Pay attention to damaged cables and hoses in particular. 5. Make sure that there is no risk of stumbling caused by cables and hoses 6. Do not eat, drink or smoke in the workshop/working area 7. Operate, service and repair the machine only when wearing the prescribed protective equipment 8. When handling the circuit board plotter, make sure that the machine cannot start (unintentionally) or is operated by a third person, for example at the computer 9. Prior to any maintenance work pull the mains plug

	10. Extract dust/material residues from the machine or remove with a brush. Do n o t blow compressed air through it!
--	--

PART TWO

MECHANICAL AND INDUSTRIAL ENGINEERING DEPARTMENT

EQUIPMENT IN THE LABS

Mechanical and Industrial Engineering Department

Refrigeration and Air conditioning Lab

Courses Related to Lab: ME-355

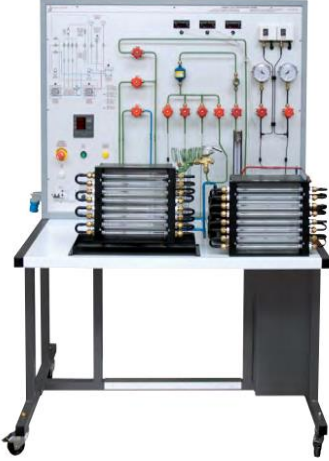
Equipment Name	General Refrigeration Cycle Trainer-1
<p>Brief Description</p>	<p>Plant starting and safety devices intervention checking • Studying the operation of a thermostatic expansion valve • Analyzing the system behavior versus the variation of: - expansion device - superheat (when the thermostatic expansion valve is used) - air flow rate at condenser and/or evaporator - refrigerant charge into the system • Plotting the cycle in the refrigerant pressure-enthalpy diagram</p>
	<p>Specifications:</p> <ul style="list-style-type: none"> • Power supply: 230 Vac 50 Hz single-phase - 500 VA (Other voltage and frequency on request) Dimensions: 140 x 80 x 180 cm Net weight: 131 kg.
<p>Equipment Photo</p>	
<p>Safety Guidance</p>	<p>Awareness required for electrical safety.</p>

Equipment Name	General Refrigeration Cycle Trainer-2
<p>Brief Description</p>	<p>Plant starting and safety devices intervention checking • Studying the operation of a thermostatic expansion valve • Analyzing the system behaviour versus the variation of: - expansion device - superheat (when the thermostatic expansion valve is used) - air flow rate at condenser and/or evaporator - refrigerant charge into the system • Plotting the cycle in the refrigerant pressure-enthalpy diagram</p>
	<p>Specifications:</p> <ul style="list-style-type: none"> • Power supply: 230 Vac 50 Hz single-phase - 500 VA (Other voltage and frequency on request) Dimensions: 140 x 80 x 180 cm Net weight: 131 kg.

Equipment Photo	
Safety Guidance	Awareness required for electrical safety.

Name of equipment	Split Air-conditioner Trainer-2
Brief Description	<p>To measure the C.O.P of cooling coil and study of the system and simulation.</p> <p>Specifications.</p> <ul style="list-style-type: none"> • The capacity of this trainer is 3.5 Tonnes • Power supply: 230 Vac 50 Hz single-phase - 500 VA (Other voltage and frequency on request) Dimensions: 140 x 80 x 180 cm Net weight: 131 kg.
Equipment Photo	
Safety Guidance	Awareness required for electrical safety.

Name of equipment	Humidity measuring apparatus
Brief Description	<p>To measure the humidity ratio in the sample air.</p> <p>Specifications:</p> <ul style="list-style-type: none"> • Humidifier • Ultrasonic Atomiser • Power Consumption: 21,6w • Low Water Cut-Off • Dehumidifier • Peltier element • cooling capacity: 56,6W (50°C ambient temperature)

	<ul style="list-style-type: none"> cooling surface: 1.600mm²
Equipment Photo	
Safety Guidance	Awareness required for electrical safety.

Name of equipment	Simple vapor compression cycle apparatus.
Brief Description	<p>To explain the working of a refrigeration cycle.</p> <ul style="list-style-type: none"> Specification: Compressor: Hermetically sealed compressor Capacity 1/3 Ton, Kirloskar make Agitator: Compatible capacity Condenser: Air cooled compatible to 1/3 Ton compressor Condenser cooling more..
Equipment Photo	
Safety Guidance	Awareness required for electrical safety.

Name of Equipment	Vapor absorption system
--------------------------	--------------------------------

Brief Description	To explain the working of absorption refrigeration system.	
	Specification: Domestic Vapor Absorption System: Packaged refrigerator working on Vapor Absorption Cycle. Refrigerator includes Electrically Heated Generator, Absorber, Condenser, Evaporator, insulated cabinet. Capacity 41 Ltrs. Cooling Capacity 50 Watt Approx., Power consumption 60 – 70 Watt <ul style="list-style-type: none"> • Energy meter: Digital Indicator • Temperature Sensors: PT 100 temperature sensors – 6 Nos. • Temperature Indicator: 6 Channel Indicator with Selector Switch, Range 0-199.9 °C • • Frame: Made of M.S. Square Tubes & Sheets, Welded & Powder coated. 	
Equipment Photo		
Safety Guidance	Awareness required for electrical safety.	

Fluid Mechanics Lab.
Courses Related to Lab: ME 353

Equipment Name	Notch Apparatus
Brief Description	To Determination Co-efficient of discharge (CD) through : <ul style="list-style-type: none"> • V notch (45 deg. and 90 deg.) • Rectangular Notch • Trapezoidal Notch
	Specifications: <ul style="list-style-type: none"> • Water Supply & Drain • Electricity : 0.5kw,220V AC, Single Phase • Floor Area : 105 x 0.75 m
Equipment Photo	
Safety Guidance	<ol style="list-style-type: none"> 1. Never immerse in water. But, it is rain resistant. 2. Never connect parts wet hands, causes electric shock.

Equipment Name	Venturi meter Apparatus
Brief Description	The Venturi meter is a device used to measure the flow rate. As shown, it consists of a tapering contraction section, along which the fluid accelerates towards a short cylindrical throat, followed by a section, which diverges, back to its original diameter.
	Specifications: <ul style="list-style-type: none"> • Each line provided with flow control value for setting of different flow rates. • Easy to operate and replacement of Venturimeter & Orifice meter. • Flow control value at the end of each line assures full running of pipe.

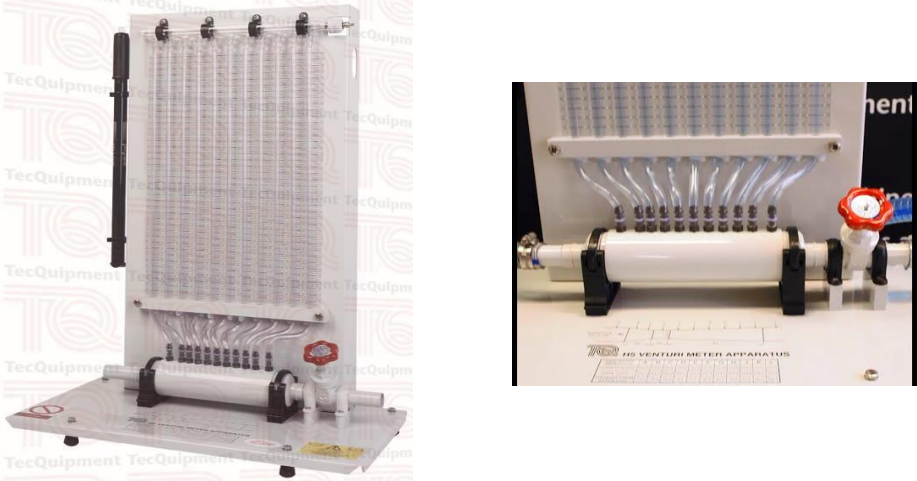
Equipment Photo	
Safety Guidance	<ol style="list-style-type: none"> 1. Never immerse in water. But, it is rain resistant. 2. Never connect parts wet hands, causes electric shock.

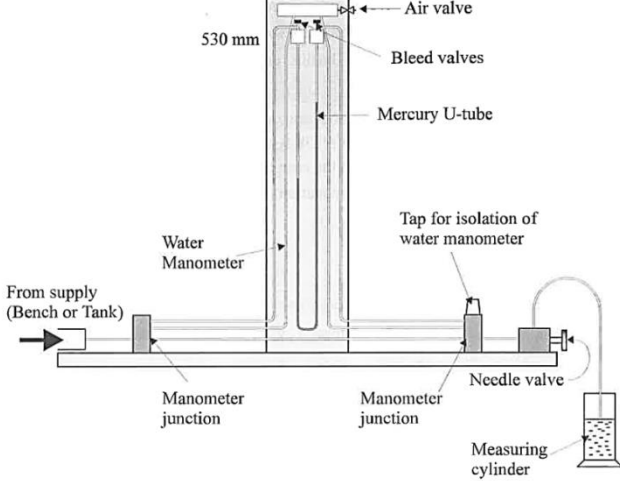
Equipment Name	Friction Factor Apparatus
Brief Description	It is use to determine experimentally the friction factor “ f ” of circular pipe.
Brief Description	Specifications: <ul style="list-style-type: none"> • Hydraulics bench to supply water to the fluid friction apparatus (the flow of water can be measured by timed volume collection).
Equipment Photo	
Safety Guidance	<ol style="list-style-type: none"> 1. Never immerse in water. But, it is rain resistant. 2. Never connect parts wet hands, causes electric shock.

Equipment Name	Pipe Losses Apparatus
Brief Description	It is use to determine the major and minor losses of the fluid flow through circular pipe.
Brief Description	Specifications: <ul style="list-style-type: none"> • The test pipes and fittings are mounted on a tubular frame carried on castors. Water is fed in from the hydraulics bench via the barbed connector, flows through the network of pipes and fittings, and is fed back into the volumetric tank via the exit tube. The pipes are arranged to provide facilities for testing the fluid

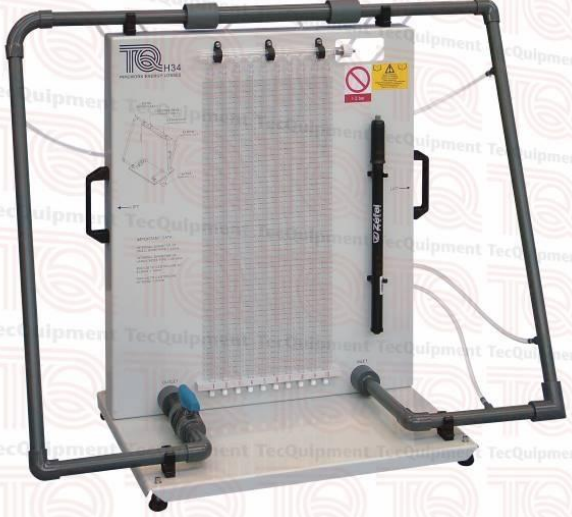
	flows through pipes, bends, valves and pipe flow metering devices.
Equipment Photo	
Safety Guidance	<ol style="list-style-type: none"> 1. Never immerse in water. But, it is rain resistant. 2. Never connect parts wet hands, causes electric shock.

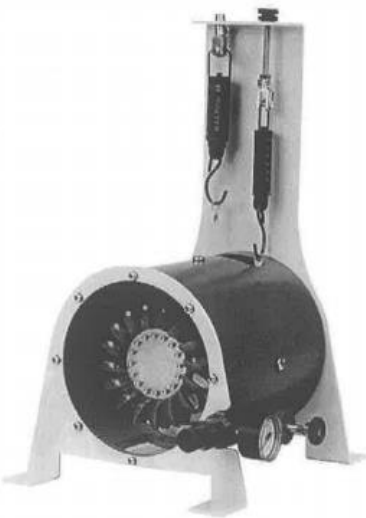
Equipment Name	Pelton Wheel Apparatus
Brief Description	<p>The purpose of this experiment is to study the constructional details and performance parameters of Pelton Turbine</p> <p>Specifications:</p> <ul style="list-style-type: none"> • Travel of the spear : 6-7 mm • Diameter of nozzle outlet: 10 mm
Equipment Photo	
Safety Guidance	<ol style="list-style-type: none"> 1. Never immerse in water. But, it is rain resistant. 2. Never connect parts wet hands, causes electric shock.

Equipment Name	Impact of Jet Apparatus
Brief Description	<p>To investigate the reaction force produced by the impact of a jet of water on to various target vanes</p> <p>Specifications:</p> <ul style="list-style-type: none"> • Diameter of nozzle: 10 mm

	<ul style="list-style-type: none"> • Height of vane above nozzle tips : 35mm • Distance from centre of vane to pivot of lever : 150mm • Mass of Jockey Weight: 0.6 kg
<p>Equipment Photo</p>	
<p>Safety Guidance</p>	<ol style="list-style-type: none"> 1. Never immerse in water. But, it is rain resistant. 2. Never connect parts wet hands, causes electric shock.

ME Workshop Equipment Lab.
Courses Related to Lab: GE 101 MIE 212 ME251

Equipment Name	Grinding Machine
Brief Description	To obtained accuracy of dimensions and good surface finish
	Specifications <ul style="list-style-type: none"> • Table clamping area (mm): 400 x 2000 • Max. Grinding Width (mm): 400 • Max. Table load (kg): 800 • Table speed (m/min): 2-5/10 • Longitudinal travel (mm): 2850 • Segment Wheel Dia. (mm): 450
Equipment Photo	
Safety Guidance	<ol style="list-style-type: none"> 1. Wear goggles for all grinding machine operations 2. Check grinding wheels for cracks before mounting. 3. Never operate grinding wheels at speeds in excess of the recommended speed. 4. Never adjust the work piece or work mounting devices when the machine is operating 5. Do not exceed recommended depth of cut for the grinding wheel or machine. 6. Wear Safety Shoes, helmet and gloves while operating the machine

Equipment Name	Lathe machine
Brief Description	used for manufacturing holes, facing , taper turning, profiling, threading and boring
	Specifications <ul style="list-style-type: none"> • Technical Specification of center lathe Machine Swing over machine bed Min. 350mm • Swing over cross slide Min. 190mm • Distance between centers Din 806-MT3 750-800mm • Turning Length 700-750mm 5. Width of bed Mini.260mm

<p>Equipment Photo</p>	
<p>Safety Guidance</p>	<ol style="list-style-type: none"> 1. Always wear eye protection 2. Wear short sleeve shirts 3. Wear shoes - preferably leather work shoes 4. Remove wrist watches, necklaces, chains and other jewelry 5. Tie back long hair so it can't get caught in the rotating work. 6. Always double check to make sure your work is securely clamped in the chuck or between centers before starting the lathe.

<p>Equipment Name</p>	<p>Shaping machine</p>
<p>Brief Description</p>	<p>Make dove tail shapes, v- shapes, straight cut, T- slots gear teeth</p> <p>Specifications</p> <ul style="list-style-type: none"> • Length of stroke : Max.500 mm • No. of speeds to Ram : To be indicated by the party • No. of Ram cycles / min. : Max.140 strokes/min. Steps to be indicated by the party • Motor Power : A.C. 7.5 H.P. Specs. & make to be given by the party • Vertical Travel of tool post slide : 150 mm (Manual feed only)
<p>Equipment Photo</p>	
<p>Safety Guidance</p>	<ol style="list-style-type: none"> 1. No alteration or adjustment should be done on the machine parts while the machine is

	<ol style="list-style-type: none"> 2. Clamps holding the work should not be adjusted while the machine is in 3. The machine is to be stopped before cleaning the metal 4. The sharp edges of the work should be handled with 5. The measuring of the work should be done only after the machine is switched 6. The operator should not seek the assistance of others for starting and stopping the 7. Machining of precise parts and internal surfaces of the workpiece are to be carried out with great care and 8. The operator should stay away from direction of the ram
--	---

Equipment Name	Vertical milling machine
Brief Description	Face milling, End Milling, Profile Milling, Pocket Milling and form Milling
	Specifications <ul style="list-style-type: none"> • Two tables, one moving side wards and the other moves forward and backwards • Spindle moves up and down • Safety guard alongside the chuck • The machine does not work unless the safety guard is in operation • Multi speed adjustment • Cooling is a must
Equipment Photo	
Safety Guidance	<ol style="list-style-type: none"> 1. Safety glasses must be worn at all times in work areas. 2. Sturdy footwear must be worn at all times in work areas. 3. Rings and jewellery must not be worn. 4. Gloves must not be worn when operating the machine. 5. Long and loose hair must be contained. 6. Close fitting/protective clothing must be worn

Equipment Name	Radial drilling machine
Brief Description	<p>Making the hole Taping Counter boring Counter Sinking</p>
	<p>Specifications</p> <ul style="list-style-type: none"> • Spindle speed range : 16-800 RPM (approx) • Spindle feed range : 0.05 to 0.5 mm/rev (approx) • Rotation of arm around column : 360 Degree • Angle of Drill Head Rotation : 360 Degree • Angle of drill head swivel from horizontal : 90 Degree upwards & downwards • Power of spindle motor : 3.7 KW or more • Horizontal traverse of arm (motorized) : 600 mm • The machine is equipped with a vice fixed on the table • Coolant is required
Equipment Photo	
Safety Guidance	<ol style="list-style-type: none"> 1. Safety glasses must be worn at all times in work areas. 2. Sturdy footwear must be worn at all times in work areas. 3. Rings and jewellery must not be worn. 4. Gloves must not be worn when operating the machine. 5. Long and loose hair must be contained. 6. Close fitting/protective clothing must be worn

Equipment Name	Hardness testing machine
Brief Description	<p>Measuring hardness of different material such as hard steel, copper, Aluminum and Plastic</p>
	<p>Specifications</p> <ul style="list-style-type: none"> • The machine shall operate on 1-ph, 50 Hz, 220 Volts AC supply. • The machine shall have following test loads ranges 5,10,20,30 & 50 kgf. • The optical magnification factor of machine shall be " 70X ".

	<ul style="list-style-type: none"> • The optical measuring range of the machine shall be 0.2mm to 1.2mm. • The machine shall have maximum test height of 200 mm. • The machine shall have scale least count of 0.001 mm. • The throat depth of the machine shall be 135 mm.
Equipment Photo	
Safety Guidance	<ol style="list-style-type: none"> 1. Stanley (the Rockwell hardness tester) is a relatively safe machine. 2. Try to resist hardness testing your body parts or the body parts of bystanders. Always wear eye protection when using the Rockwell hardness tester.

Equipment Name	Tensile Testing Machine
Brief Description	<p>Use for testing elasticity of the material, bending and elongation to measure stress, strain and modulus of elasticity</p> <p>Specifications</p> <ul style="list-style-type: none"> • Capacity Up to 100 KN • Minimum test Speed 0.01 mm/min • Maximum test Speed 500 mm /min • Width Preferably in the range of 1000-1200 mm • Depth Preferably in the range of 500-600 mm • Height Preferably in the range of 1600-2000 mm
Equipment Photo	
Safety Guidance	<ol style="list-style-type: none"> 1. Safety glasses should be worn. 2. Gloves must be worn 3. Safety shoes must be worn

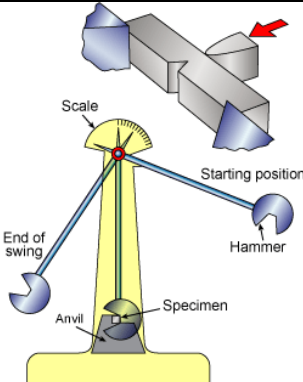
Equipment Name	Impact Testing Machine
Brief Description	Use to measure the energy absorption by the material due to impact force on the V- Notch specimen
	Specifications <ul style="list-style-type: none"> • Weight of hammer: 0.5 Kg • Pendulum: One-arm design, nominal* base capacity: 24 in-lbs (2 ft-lbs or 2.7 J) • 2 ft elevation and adjustable depending on chosen angle of fall.
Equipment Photo	 <p>The diagram illustrates the components of an impact testing machine. A pendulum arm is shown in its starting position, with a hammer head at the end. A scale is attached to the arm to measure the angle of fall. The hammer is shown striking a specimen on an anvil. Labels include: Scale, Starting position, Hammer, End of swing, Anvil, and Specimen.</p>
Safety Guidance	Make sure that on one in the path that the swinging hammer is about to take

Equipment Name	Fatigue Machine
Brief Description	Use for Fatigue testing machines apply cyclic loads to test specimens. Fatigue testing is a dynamic testing mode and can be used to simulate how a component/material will behave/fail under real life loading/stress conditions
	Specifications <ul style="list-style-type: none"> • Max. bending moment (Kg. cm) : 200 • Ranges : 1 - Kg.cm II - Kg.cm: 25- 125 125-200 • Testing dia of specimen (mm): 8 • Rotating speed in RPM: 4200
Equipment Photo	 <p>The photograph shows a green fatigue testing machine with a control panel and a specimen holder, mounted on a wooden table.</p>
Safety Guidance	<ol style="list-style-type: none"> 1. Hard hats should be worn whenever 2. Safety footwear should be worn 3. Overalls should be worn 4. Eye protection should be worn 5. Face masks should be worn
Equipment Name	CNC Milling Machine

Brief Description	Use for Face milling, End Milling, Profile Milling, Pocket Milling and form Milling
	Specifications <ul style="list-style-type: none"> • Table: 1067 x 230(42" x 9") • X-axis travel (manual): 730 • Y-axis travel: 310 • Z-axis travel: 406
Equipment Photo	
Safety Guidance	<ol style="list-style-type: none"> 1. Safety glasses must be worn at all times in work areas. 2. Sturdy footwear must be worn at all times in work areas. 3. Rings and jewellery must not be worn. 4. Gloves must not be worn when operating the machine. 5. Long and loose hair must be contained. 6. Close fitting/protective clothing must be worn

Equipment Name	CNC Lathe Machine
Brief Description	Used for manufacturing holes, facing , taper turning, profiling, threading and boring
	Specification <ul style="list-style-type: none"> • Swing over Bed: 460 (18.11") • Swing over cross slide: 230 (9.06") • Width of Bed: 317 (12.48") • Length of Bed: 1490(58.66")
Equipment Photo	
Safety Guidance	<ol style="list-style-type: none"> 1. Always wear eye protection 2. Wear short sleeve shirts 3. Wear shoes - preferably leather work shoes 4. Remove wrist watches, necklaces, chains and other jewelry 5. Tie back long hair so it can't get caught in the rotating work.

	6. Always double check to make sure your work is securely clamped in the chuck or between centers before starting the lathe.
--	--

Equipment Name	Electric sawing machine
Brief Description	Use for cutting metals, plastics and wood
	Specification <ul style="list-style-type: none"> • Standard Accessories • Complete hydraulic System • Complete coolant System • Step pulley with V-belt • Carbide & roller blade guide
Equipment Photo	
Safety Guidance	<ol style="list-style-type: none"> 1. Keep hands away from the saw blade of the hacksawing machine or band sawing machine when in operation. 2. Ensure the power supply is disconnected prior to removal or installation of saw blades. 3. Use a miter guide attachment, work-holding jaw device, or a wooden block for pushing metal workpieces into the blade of the bandsaw wherever possible. Keep fingers well clear of the blade at all times. 4. When removing and installing band saw blades, handle the blades carefully. A large springy blade can be dangerous if the operator does not exercise caution.

Equipment Name	Electric Arc Welding Machine
Brief Description	Use to join two pieces together by means of an electrodes
	Specification <ul style="list-style-type: none"> • Rated input voltage (V): 1PH AC220 • Rated input current (A): 32A • Net weight (KG): 15 Kg • Dimension of machine (mm): 340×140×215

<p>Equipment Photo</p>	
<p>Safety Guidance</p>	<ol style="list-style-type: none"> 1. To prevent injury to personnel, extreme caution should be exercised when using any types of welding equipment. Injury can result from fire, explosions, electric shock, or harmful agents. Both the general and specific safety precautions listed below must be strictly observed by workers who weld or cut metals. 2. Do not permit unauthorized persons to use welding or cutting equipment. 3. Do not weld in a building with wooden floors, unless the floors are protected from hot metal by means of fire resistant fabric, sand, or other fireproof material. Be sure that hot sparks or hot metal will not fall on the operator or on any welding equipment components. 4. Remove all flammable material, such as cotton, oil, gasoline, etc., from the vicinity of welding. 5. Before welding or cutting, warn those in close proximity who are not protected to wear proper clothing or goggles. 6. Remove any assembled parts from the component being welded that may become warped or otherwise damaged by the welding process. 7. Do not leave hot rejected electrode stubs, steel scrap, or tools on the floor or around the welding equipment. Accidents and/or fires may occur. 8. Keep a suitable fire extinguisher nearby at all times. Ensure the fire extinguisher is in operable condition.

<p>Equipment Name</p>	<p>Casting Furnace</p>
<p>Brief Description</p>	<p>Use to melt metals such as steel, aluminum , copper and brass for the purpose of casting</p> <p>Specification</p> <ul style="list-style-type: none"> • Temperature: 300 – 2000 C • Max. Capacity : 30 kg

Equipment Photo	
Safety Guidance	<ol style="list-style-type: none"> 1. Wear safety goggles 2. Wear apron 3. Wear safety shoes 4. Wear gloves 5. Use special plunger to hold the molten metal

Equipment Name	Cut-off Machine
Brief Description	Use for Cutting different types of metals
	Specification <ul style="list-style-type: none"> • The spindle speed ranges from 1000-3000 rpm • Diameter of up to 105 mm
Equipment Photo	
Safety Guidance	<ol style="list-style-type: none"> 1. Ensure all adjustments to machine are secure before making a cut. 2. Use the vice to clamp the work and properly support the over-hanging portion of the workpiece level with the base of the machine. 3. Allow the machine to reach full speed before contacting the workpiece. 4. Ease the abrasive disc against the workpiece when starting to cut. 5. Keep hands away from the blade and cutting area. 6. After finishing the cut, release the switch, hold the saw arm down and wait for the disc to stop before removing work or off-cut piece. 7. Before making any adjustments, disconnect the plug from the power source and bring the machine to a complete standstill.

Equipment Name	Polisher Machine
-----------------------	-------------------------

Brief Description	Use to Polishing surfaces to obtain good surface finish for materials such as steel, aluminum , copper and brass.
	Specification: <ul style="list-style-type: none"> • Operating Voltage : 220 V, 50 Hz • Speed : Speed control knob with display • Timer : 90 minutes with 1 minute step size • Polishing Plates & consumables • Slurry System : provision for feeding slurry to polishing machine with the control of feed rate
Equipment Photo	
Safety Guidance	<ol style="list-style-type: none"> 1. Wear safety gloves 2. Wear safety goggles 3. Never put hands on the polishing wheel 4. Wear helmet

Equipment Name	Shearing Machine
Brief Description	Use for Cutting sheet metals only not more than 3 mm thick
	Specification: <ul style="list-style-type: none"> • Max cut thickness: 3 mm • Max length of cut : 500 mm
Equipment Photo	
Safety Guidance	<ol style="list-style-type: none"> 1. Wear gloves 2. Never put hands on the blades 3. Never leave the lifting arm blade in the up position

Equipment Name	Spot Welding Machine
-----------------------	-----------------------------

Brief Description	Use to join two pieces of sheet metals in a spot weld by using electrical energy, pressure and thermal energy
	Specification: <ul style="list-style-type: none"> • Max thickness of sheet metal : 1 mm • No of phase: 3 • Voltage : 220V
Equipment Photo	
Safety Guidance	<ol style="list-style-type: none"> 1. Wear gloves 2. Wear safety goggles 3. Make sure that the operator does not place his hands between the electrodes

Equipment Name	Rolling Machine
Brief Description	Use to bend sheet metals for different shapes
	Specification: <ul style="list-style-type: none"> • Max Thickness: 3 mm • Width of Sheet: 300 mm (Max)
Equipment Photo	
Safety Guidance	<ol style="list-style-type: none"> 1. Wear gloves 2. Never put the hands between the rollers 3. Wear safety shoes

Equipment Name	Torsion Machine
-----------------------	------------------------

Brief Description	Use to measure the twist in the metal rod when subjected to rotation
	Specification: <ul style="list-style-type: none"> • Length of rod: 300mm • Diameter: 8mm
Equipment Photo	
Safety Guidance	<ol style="list-style-type: none"> 1. Wear gloves 2. Wear apron 3. Start with lower speed and increase gradually

Mechanical & Industrial Engineering Department
Mechanical Power Lab.
Courses Related to Lab: ME 493 & ME 494

Equipment Name	Linear Heat Conduction Apparatus
Brief Description	<p>This equipment is use to study Fourier's equation in a one-dimensional system in steady-state conditions</p> <p>Specifications:</p> <ul style="list-style-type: none"> • Dimensions: 460 x 460 x 470 mm • Weight: 10 kg
Equipment Photo	
Safety Guidance	Required rate of water supply is 1.5 litres/min

Equipment Name	Notch Apparatus
Brief Description	<p>To Determination Co-efficient of discharge (CD) through :</p> <ul style="list-style-type: none"> • V notch (45 deg. and 90 deg.) • Rectangular Notch • Trapezoidal Notch <p>Specifications:</p> <ul style="list-style-type: none"> • Water Supply & Drain • Electricity : 0.5kw,220V AC, Single Phase • Floor Area : 105 x 0.75 m
Equipment Photo	
Safety Guidance	<ol style="list-style-type: none"> 1. Never immerse in water. However, it is rain resistant. 2. Never connect parts wet hands, causes electric shock.

Equipment Name	Radial Heat Conduction Apparatus
Brief Description	This equipment is use to study the radial heat conduction in steady-state condition
	Specifications: <ul style="list-style-type: none"> • Dimensions: 420 x 420 x 320 mm • Weight: 9 kg
Equipment Photo	
Safety Guidance	Required rate of water supply is 1.5 litres/min

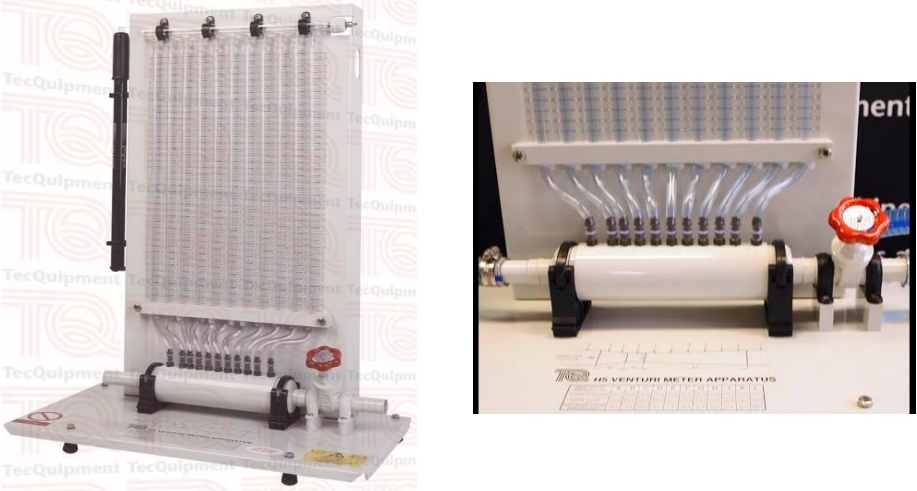
Equipment Name	Venturi meter Apparatus
Brief Description	The Venturi meter is a device used to measure the flow rate. As shown, it consists of a tapering contraction section, along which the fluid accelerates towards a short cylindrical throat, followed by a section, which diverges, back to its original diameter.
	Specifications: <ul style="list-style-type: none"> • Each line provided with flow control value for setting of different flow rates. • Easy to operate and replacement of Venturimeter & Orifice meter. • Flow control value at the end of each line assures full running of pipe.
Equipment Photo	
Safety Guidance	<ol style="list-style-type: none"> 1. Never immerse in water. However, it is rain resistant. 2. Never connect parts wet hands, causes electric shock.

Equipment Name	Friction Factor Apparatus
Brief Description	It is use to determine experimentally the friction factor “ f ” of circular pipe.
	Specifications: Hydraulics bench to supply water to the fluid friction apparatus (the flow of water can be measured by timed volume collection).
Equipment Photo	
Safety Guidance	<ol style="list-style-type: none"> 1. Never immerse in water. However, it is rain resistant. 2. Never connect parts wet hands, causes electric shock.

Equipment Name	Petrol engine model carburetor - sectioned
Brief Description	This model to understand the working principal of petrol engine.
	Specifications: <ul style="list-style-type: none"> • Dimensions: 40 x 30 x 62 mm • Weight: 9 kg
Equipment Photo	
Safety Guidance	NIL

Equipment Name	Pipe Losses Apparatus
-----------------------	------------------------------

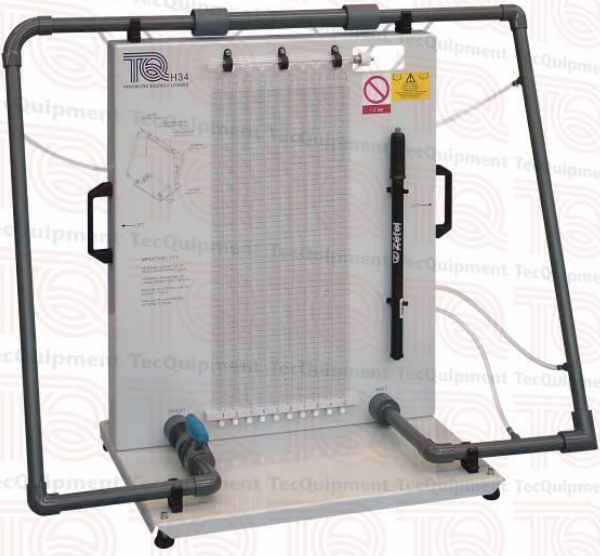
Brief Description	It is use to determine the major and minor losses of the fluid flow through circular pipe.
	<p>Specifications:</p> <p>The test pipes and fittings are mounted on a tubular frame carried on castors. Water is fed in from the hydraulics bench via the barbed connector, flows through the network of pipes and fittings, and is fed back into the volumetric tank via the exit tube. The pipes are arranged to provide facilities for testing the fluid flows through pipes, bends, valves and pipe flow metering devices.</p>
Equipment Photo	
Safety Guidance	<ol style="list-style-type: none"> 1. Never immerse in water. However, it is rain resistant. 2. Never connect parts wet hands, causes electric shock.

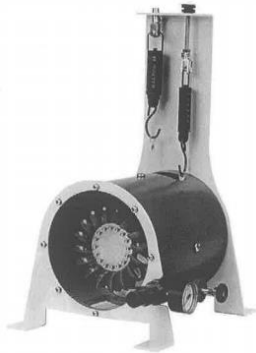
Equipment Name	Pelton Wheel Apparatus
Brief Description	The purpose of this experiment is to study the constructional details and performance parameters of Pelton Turbine
	<p>Specifications:</p> <ul style="list-style-type: none"> • Travel of the spear : 6-7 mm • Diameter of nozzle outlet: 10 mm
Equipment Photo	
Safety Guidance	<ol style="list-style-type: none"> 1. Never immerse in water. However, it is rain resistant. 2. Never connect parts wet hands, causes electric shock.

Equipment Name	Impact of Jet Apparatus
-----------------------	--------------------------------

Brief Description	To investigate the reaction force produced by the impact of a jet of water on to various target vanes
	Specifications: <ul style="list-style-type: none"> • Diameter of nozzle: 10 mm • Height of vane above nozzle tips : 35mm • Distance from centre of vane to pivot of lever : 150mm • Mass of Jockey Weight: 0.6 kg
Equipment Photo	
Safety Guidance	<ol style="list-style-type: none"> 1. Never immerse in water. However, it is rain resistant. 2. Never connect parts wet hands, causes electric shock.

PART THREE.

CIVIL AND ENVIRONMENTAL ENGINEERING DEPARTMENT



EQUIPMENT IN THE LABS.

Civil and Environmental Engineering Department

6/1/4/R117/1

Soil Mechanics Engineering Lab
Courses Related to Lab: CE210 – CE311 – CE 423 – CE 498 – CE 499

Equipment Name	Drying oven with timer
Brief Description	Use: Drying the wet materials.
	Specifications: <ul style="list-style-type: none"> • 225 liter capacity, 220 v with dial thermometer 0-300deg.C
Equipment Photo	
Safety Guidance	<ol style="list-style-type: none"> 1. NEVER expose to extreme heat, it affects accuracy. 2. If not used, disconnect electricity.

Equipment Name	Casagrande Apparatus
Brief Description	Use: Measuring the liquid limit of soil.
	Specifications: <ul style="list-style-type: none"> • Hand operated complete with grooving tools.
Equipment Photo	
Safety Guidance	<ol style="list-style-type: none"> 1. NEVER expose to extreme heat, it affects accuracy. 2. If not used, disconnect electricity.
	Specifications: <ul style="list-style-type: none"> • Manually operated prototype.
Equipment Photo	
Safety Guidance	<ol style="list-style-type: none"> 1. NEVER expose to extreme heat, it affects accuracy. 2. If not used, disconnect electricity.

Equipment Name	Sieves Set
Brief Description	Use: Grain size distribution of soil.
	Specifications: <ul style="list-style-type: none"> (ASTM Test sieves)
Equipment Photo	
Safety Guidance	<ol style="list-style-type: none"> 1. NEVER expose to extreme heat, it affects accuracy. 2. If not used, disconnect electricity.

Equipment Name	Mechanical Sieve Shaker Machine
Brief Description	Use: Handling and vibrating the sieve set to separate soil particles.
	Specifications: <ul style="list-style-type: none"> Sieve Shaker for 200 & 300mm diam. 220 v.
Equipment Photo	
Safety Guidance	<ol style="list-style-type: none"> 1. NEVER expose to extreme heat, it affects accuracy. 2. If not used, disconnect electricity.

Equipment Name	Soil Hydrometer Apparatus
Brief Description	Use: Measuring the specific gravity of soil samples.
	Specifications: <ul style="list-style-type: none"> Long Stem Soil Hydrometer Apparatus.
Equipment Photo	
Safety Guidance	<ol style="list-style-type: none"> 1. NEVER expose to extreme heat, it affects accuracy. 2. If not used, disconnect electricity.
Equipment Name	Compaction Molds

Brief Description	Use: Applying the soil compaction test.
	Specifications: <ul style="list-style-type: none"> • Standard & modified, metal compaction molds.
Equipment Photo	
Safety Guidance	1. NEVER expose to extreme heat, it affects accuracy.

Equipment Name	Soil Compactor
Brief Description	Use: Applying the soil compaction test.
	Specifications: <ul style="list-style-type: none"> • Automatic soil compactor complete with all acc. 4 & 6 inches molds
Equipment Photo	
Safety Guidance	1. NEVER expose to extreme heat, it affects accuracy. 2. If not used, disconnect electricity.

Equipment Name	Constant Head Permeameter.
Brief Description	Use: Measuring the soil permeability.
	Specifications: <ul style="list-style-type: none"> • Constant head permeability cell 75mm diameter.

Equipment Photo	
Safety Guidance	<ol style="list-style-type: none"> 1. NEVER expose to extreme heat, it affects accuracy. 2. If not used, disconnect electricity.

Equipment Name	Manometer Tubes.
Brief Description	<p>Use: Measure gas pressure relative to atmospheric pressure.</p> <p>Specifications:</p> <ul style="list-style-type: none"> • Manometer Tubes with stands.
Equipment Photo	
Safety Guidance	<ol style="list-style-type: none"> 1. NEVER expose to extreme heat, it affects accuracy. 2. If not used, disconnect electricity.

Equipment Name	Compaction Permeameter
Brief Description	<p>Use: Measures the permeability of soil.</p> <p>Specifications:</p> <ul style="list-style-type: none"> • Compaction Permeameter, 101.6 mm

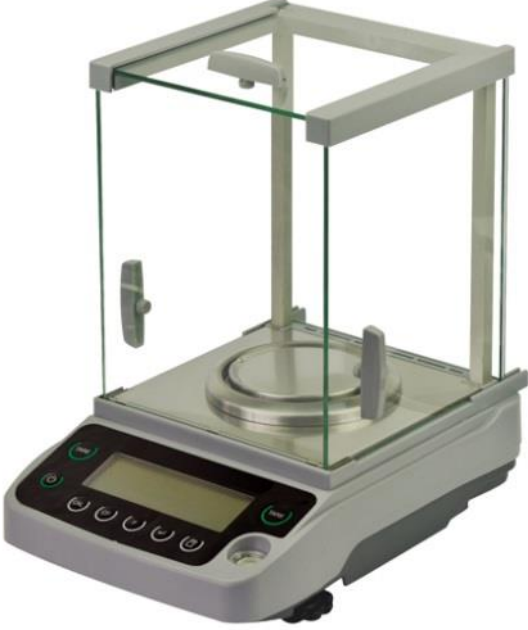
Equipment Photo	
Safety Guidance	1. NEVER expose to extreme heat, it affects accuracy.
Equipment Name	Analytical Weighing Balance
Brief Description	Use: Measures the permeability of soil. Specifications: <ul style="list-style-type: none"> Measures up to 16110 g with an accuracy less than 0.01 g.
Equipment Photo	
Safety Guidance	1. NEVER expose to extreme heat, it affects accuracy. 2. If not used, disconnect electricity.

Surveying Engineering Lab.
Courses Related to Lab: CE 370, CE 371, CE 372, CE 474

Equipment Name	Total station Instrument
Brief Description	Use: To measure the horizontal and vertical angles between features. Also, can be used to measure the direct distance between the instrument and the features.
	Specifications: High accuracy of three values (1 or 6 or 20) Seconds for angles.
Equipment Photo	
Safety Guidance	<ol style="list-style-type: none"> 1. NEVER immerse in water. But, it is rain resistant. 2. NEVER expose to extreme heat, it affects accuracy. 3. NEVER use near flammable gases, liquids or Coal mines. It ignites explosively. 4. NEVER connect parts wet hands, causes electric shock. 5. 5. If not used for a month, remove the battery.

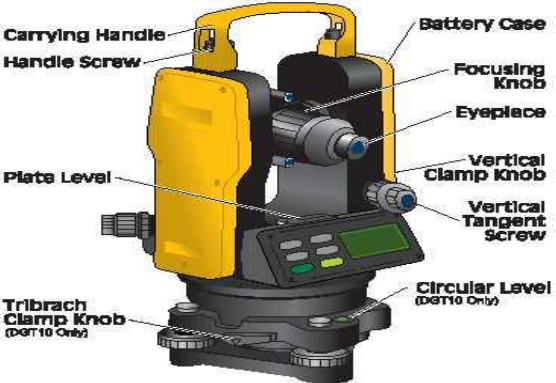
Equipment Name	Theodolite Instrument
Brief Description	Use. To measure the horizontal and vertical angles between features. Also, can be used to measure the indirect distance between the instrument and the features.
	Specifications. Accuracy up to (5) seconds when measuring angles.
Equipment Photo	
Safety Guidance	<ol style="list-style-type: none"> 1. NEVER immerse in water. But, it is rain resistant. 2. NEVER expose to extreme heat, it affects accuracy.

3. 3. If not used for a month, remove the battery.

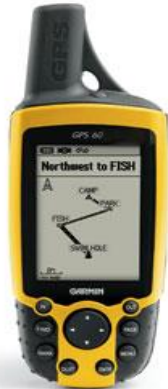
Equipment Name	Global Positioning Systems Device.
Brief Description	Use: Detects the coordinates of any location on earth.
	Specifications: Measuring coordinates, directions and elevations from sea level.
Equipment Photo	
Safety Guidance	<ol style="list-style-type: none"> 1. NEVER immerse in water. But, it is rain resistant. 2. NEVER expose to extreme heat, it affects accuracy. 3. NEVER use near flammable gases, liquids or Coal mines. 4. NEVER connect parts wet hands, causes electric shock. 5. If not used for a month, remove the battery.

Equipment Name	Automatic Leveling Device
Brief Description	Use: Measures the difference in elevation between points.
	Specifications: Very high accuracy to the part of cm.
Equipment Photo	
Safety Guidance	<ol style="list-style-type: none"> 1. NEVER immerse in water. But, it is rain resistant. 2. NEVER expose to extreme heat, it affects accuracy.

	<ol style="list-style-type: none"> 3. NEVER use near flammable gases, liquids or Coal mines. 4. NEVER connect parts wet hands, causes electric shock. 5. If not used for a month, remove the battery.
--	--

Equipment Name	Planimeter Surveying Device
Brief Description	Use: Measures the areas pf non symmetrical polygons.
	Specifications: Very high accuracy to the part of square cm.
Equipment Photo	
Safety Guidance	<ol style="list-style-type: none"> 1. NEVER immerse in water. But, it is rain resistant. 2. NEVER expose to extreme heat, it affects accuracy. 3. NEVER use near flammable gases, liquids or Coal mines. 4. NEVER connect parts wet hands, causes electric shock. 5. If not used for a month, remove the battery.

Civil and Environmental Engineering Department
Highways Lab
Courses Related to Lab: CE 380, CE 381, CE 482, CE 486

Equipment Name	Marshall Test machine
Brief Description	Use: To measure Marshall stability of a test specimen is the maximum load required to produce failure when the specimen is preheated to a prescribed temperature placed in a special test head and the load is applied at a constant strain (5 cm per minute). While the stability test is in progress dial gauge is used to measure the vertical deformation of the specimen. The deformation at the failure point expressed in units of 0.25 mm is called the Marshall flow value of the specimen.
	Specifications: <ul style="list-style-type: none"> Imposing vertical Load capability, strain gauge measurements
Equipment Photo	
Safety Guidance	<ol style="list-style-type: none"> 1. NEVER connect hands while activating load, causes hand broken. 2. NEVER immerse in water. But, it is rain resistant. 3. NEVER expose to extreme heat, it affects accuracy. 4. If not used disconnect electricity.

Equipment Name	Los Angeles abrasion test machine
Brief Description	Use. To measure of degradation of mineral aggregates of standard grading resulting from a combination of actions including abrasion or attrition, impact, and grinding in a rotating steel drum containing a specified number of steel spheres. The Los Angeles (L.A.) abrasion test is a common test method used to indicate aggregate toughness and abrasion characteristics. Aggregate abrasion characteristics are important because the constituent aggregate in HMA must resist crushing, degradation and disintegration in order to produce a high quality HMA.
	Specifications. <ul style="list-style-type: none"> Steel Spherical Balls, Machine (The machine is equipped with a counter. The machine shall consist of hollow steel cylinder

	closed at both ends. An opening in cylinder shall be provided for introducing the sample, Sieves
Equipment Photo	
Safety Guidance	<ol style="list-style-type: none"> 1. NEVER connect hands while activating load, causes hand broken. 2. NEVER immerse in water. 3. NEVER expose to extreme heat, it affects accuracy. 4. If not used disconnect electricity

Equipment Name	Pavement core drilling machine
Brief Description	<p>Use: To take Samples of asphalt pavement after roads constructed. It collects using the coring method may be used to evaluate various characteristics of an asphalt concrete pavement for construction quality control testing, quality assurance testing and product acceptance testing. Core samples may also be used for research testing purposes</p> <p>Specifications:</p> <ul style="list-style-type: none"> • 6 HP, 4-stroke high quality petrol engine • Coring range up to 200 mm dia. • Robust, compact and portable • Vertical screw feet • Complete with strap wrench and spanner • Wide range of coring bits with fixed standard coupling available
Equipment Photo	

Safety Guidance	<p>NEVER connect hands while activating machine, causes hand broken.</p> <ol style="list-style-type: none"> 1. NEVER immerse in water. 2. NEVER expose to extreme heat, it affects accuracy. 3. 4. If not used disconnect electricity
------------------------	--

Equipment Name	Hot air oven
Brief Description	<p>Use: Hot air ovens are electrical device which use heat to dry soil samples. An air circulating fan helps in uniform distribution of the heat.</p> <p>Specifications:</p> <ul style="list-style-type: none"> • It can be operated from 50 to 200 °C, using a thermostat to control the temperature. Their double walled insulation keeps the heat in and conserves energy, the inner layer being a poor conductor and outer layer being metallic. There is also an air filled space in between to aid insulation. These are fitted with the adjustable wire mesh plated trays or aluminium trays and may have an on/off rocker switch, as well as indicators and controls for temperature and holding time.
Equipment Photo	
Safety Guidance	<ol style="list-style-type: none"> 1. NEVER connect hands while activating heat, causes temperature shock. 2. NEVER immerse in water. But, it is rain resistant. 3. NEVER expose to extreme heat, it affects accuracy. 4. 4. If not used disconnect electricity

Civil and Environmental Engineering Department
Geographic Information Systems Lab.
Courses Related to Lab: CE 475, CE 477, 478

Equipment Name	Personal Computer with Software
Brief Description	<p>Use: Analyzes the satellite images and apply the geographic information systems tools to extract the results.</p> <p>Specifications: ERDAS IMAGINE software. Arc GIS software.</p>
Equipment Photo	
Safety Guidance	NEVER expose to extreme heat, it affects accuracy.

Equipment Name	Plotter Printer.
Brief Description	<p>Use: Prints out the maps resulted from the analysis of data.</p> <p>Specifications: Very large dimensions. (A0) size.</p>
Equipment Photo	
Safety Guidance	1. NEVER expose to extreme heat, it affects accuracy.

Equipment Name	Scanner Printer
Brief Description	<p>Use. Converting the hardcopy maps into softcopy files on computer.</p> <p>Specifications: Large dimensions. (A2) maps size.</p>

Equipment Photo	
Safety Guidance	NEVER expose to extreme heat, it affects accuracy.

Equipment Name	Main Server
Brief Description	Use. Control and share data with multi computers devices.
	Specifications: Dell Poweredge R710 Rack chassis for up to 6 x 3.5 " HDDs, Intel Xeon X5660 processor, 8GB memory for ICPU, 1066 MHz, 300 GB SAS.
Equipment Photo	
Safety Guidance	NEVER expose to heat, it is so harmful

Civil and Environmental Engineering Department

Properties of Materials Lab.

Courses Related to Lab: CE 212, CE 313

Equipment Name	Los Angeles Abrasion Machine
Brief Description	Use: The test covers the procedure for testing crushed rock, crushed slag, uncrushed and crushed gravel for resistance to abrasion in the Los Angeles Testing Machine with an abrasive charge. This machine can be used for determining the abrasion limits given in ASTM C33.
	Specifications: <ul style="list-style-type: none">• The machine consists of a rolled steel drum having an inside dia. of 711 mm and internal length 508 mm.• The drum is rotated by a speed reducer driven by an electric motor at a speed of between 31 and 33 r.p.m. The machine is equipped with an automatic counter, which can be preset to the required number of revolutions of the drum or the total working time. The unit is supplied with the abrasive charge (Set of 12 abrasive charges conforming to ASTM/AASHTO standards).
Equipment Photo	 A blue Los Angeles Abrasion Machine is shown. It consists of a large, horizontal, cylindrical drum mounted on a blue metal frame. The drum is connected to a motor and a speed reducer. A control box with a digital display and buttons is attached to the side of the machine. The machine is designed for testing the abrasion resistance of materials like crushed rock and gravel.
Safety Guidance	<ol style="list-style-type: none">1. Use the emergency-red-stop button in an emergency situation only.2. Recommendation: Build a protective guard railing around the unit or a cover over the machine to prevent unauthorized use.3. Keep hands, clothing and other objects away from moving parts when the machine is in operation.

Equipment Name	Tile Abrasion Testing Machine (AIM 481)	
Brief Description	Use: This is used for determination of resistance to wear for cement concrete flooring tiles.	
	Specifications: <ul style="list-style-type: none"> • Tiles specimen of size 7.06cm x 7.06cm is pressed face-wise under specific load on a grinding path and abrasive powder is evenly spread on the rotating grinding path and after specific number of revolutions of the grinding disc the second parallel side of the tile is subjected to wear for similar number of rotations. • The machine consists of a disc rotating at a speed of 30 rpm in a circular tray. Load applied is 30kgf. • Load applied is 30kgf. A funnel is fitted to evenly spread abrasive powder on the grinding path. • The wear of the tile is measured on a thickness gauge specifically made for the purpose. • A bracket is provided to hold the specimen. A counter balance lever loads the specimen. • A pre-set counter automatically stops the machine after 22 revolutions. This counter is re-adjustable. 	
Equipment Photo	 <p style="text-align: center; color: red; font-weight: bold;">TILE ABRASSION TEST M/C</p>	
Safety Guidance	<ol style="list-style-type: none"> 1. Keep hands, clothing and other objects away from moving parts when the machine is in operation 2. Anyone who is not familiar with the operating instructions must be supervised when using the machine 	

Equipment Name	Stirring heating plate	
Brief Description	Use: The stirring heating plate or heated stirring heating plate has been developed to heat and mix fluids contained in laboratory receptacles such as flasks, test tubes and beakers.	
	Specifications: <ul style="list-style-type: none"> • Magnetic Stirrer with Hot Plate 145 mm dia. • Temperature range 500° C, speed range up to 1250 1/min. 	

	<ul style="list-style-type: none"> • Max. Stirring capacity 20 l. 230 V, 50 Hz
Equipment Photo	
Safety Guidance	<ol style="list-style-type: none"> 1. Verify that the heating plate is disconnected and cold. This prevents the risk of electric shock or burns. 2. Clean the equipment in a vertical position to avoid cleaning agents from reaching internal components. 3. Use a mild detergent. 4. Apply to the external surfaces using a piece of cloth of similar texture to that of a handkerchief. 5. Verify that the equipment is completely dry before connecting it again.

Equipment Name	Sieve Shaker
Brief Description	<p>Use: Used to separate aggregates by their size.</p> <p>Specifications:</p> <ul style="list-style-type: none"> • Sieve Capacity <ul style="list-style-type: none"> ✓ 8 sieves (200 mm Dia x 50 mm H) ✓ 16 sieves (100 mm Dia x 25 mm H) • Vibration Source Electromagnetic vibrator • Construction Cast Iron, Painted Mild steel • Set Time 0 ~ 99 min • Vibration Frequency 3000 times / min • Noise Level <ul style="list-style-type: none"> ✓ > 61 db w/o sieves at max. power level ✓ > 71 db w/ sieves & material at max. power level • Power Supply 220 Volts.
Equipment Photo	
Safety Guidance	<ol style="list-style-type: none"> 1. DO NOT operate the machine without having all covers and case in place. 2. ALWAYS level the machine prior to operation. 3. Stop the machine immediately and re-level if excessive vibration or machine movement occurs. 4. DO NOT operate the machine without making sure all three clamps on the top platform are secure.

	<ol style="list-style-type: none"> 5. Use caution to avoid pinching fingers when raising or lowering the sieve cover and when tightening the end clamp knobs. 6. Keep all parts of your body away from moving parts of the machine while it is operating. 7. ALWAYS unplug or disconnect machine from the power source when the unit is not in operation. 8. ALWAYS wear safety glasses when operating, maintaining, or repairing this machine. 9. Make sure the sieves are stacked securely fitting them on top of each other. Place the black cap on the top sieve before lowering the arm onto the stack
--	--

Equipment Name	Mixing Apparatus
Brief Description	<p>Use: is a heavy duty kitchen mixer that is being used for mixing concrete and cement paste.</p> <p>Specifications:</p> <ul style="list-style-type: none"> • Speeds (rpm) Paddle Mixing Head Shaft • Low (Manual Speed 1) 140 ± 5 62 ± 5 • High (Manual Speed 2) 285 ± 10 125 ± 10 • Overall dimensions Length width height • Basic machine 530 mm 350 mm 580 mm • Machine with sand dispenser 530 mm 390 mm 715 mm • Bowl capacity (approx.) 5 litres • Weight (mixer only) 54 kg • Motor rating 180 watts • Automatic Program 1 EN196 Part 1 : 2005 • Automatic Program 2 EN196 Part 3 : 2005 • Nudge Speed (10 RPM) For positioning of beater to check beater gap.
Equipment Photo	
Safety Guidance	<ol style="list-style-type: none"> 1. Misuse of this equipment may result in serious injury to personnel.

	<ol style="list-style-type: none"> 2. Only use the equipment for its intended purpose, as described in this manual. 3. Do not attempt to operate the equipment with covers removed. 4. Only connect to the correct electrical supply, as stated on the rating plate. 5. Refer to Installation section before installing machine. 6. Do not operate machine with wet hands.
--	---

Equipment Name	Automatic Vicat Needle Apparatus
Brief Description	<p>Use: Used for the determination of initial and final setting time of cement and mortar according to various standards.</p>
	<p>Specifications:</p> <ul style="list-style-type: none"> • up to 5 test sequences can be programmed and memorized by the operator. Digital display showing all relevant results during the test. Appr. • By Windows software, available as an option, all test data can be received, memorized, evaluated etc. • Supplied including needle 1.13 mm, consistency probe and vicat mould. Dim. appr. 400x200x570 mm, weight appr. 13 kg. 230 V, 50 Hz. • Power Supply 220 - 240 V AC, 50 - 60 Hz, 1 ph
Equipment Photo	
Safety Guidance	<ol style="list-style-type: none"> 1. Before starting to use the equipment, ensure that all components are in good working order. 2. Check there are no defective or damaged parts. If necessary, repair or replace any damaged part. 3. Be aware of the possibility of electric shocks (both direct and indirect), which could be caused by 4. Electric system failures. 5. Do not subject the appliance to impacts or shocks. 6. Do not expose the appliance to fire, extreme temperatures or welding sparks. 7. Do not allow corrosive substances to come into contact with the appliance.

8. Do not wash the machine with jets of water.

Equipment Name	Ultrasonic pulse velocity Apparatus
Brief Description	<p>Use: Used rfr the non destructive evaluation of concrete homogeneity and determination of Dynamic Elastic Modulus and depth of carcks. It measures the transit time of ultrasonic pulses through concrete for inspection of new and old structures, slabs, columns, walls, fire damaged areas, precast and prestressed beams, cylinders and other concrete forms.</p> <p>Specifications:</p> <ul style="list-style-type: none"> • Microprocessor incorporated • Battery operated by internal rechargeable battery pack (2400 MAh) and External charger • 14 working hours using I Hz pulse rate • RS 232 output for PC or printer • Connectable to oscilloscope • Transit time measurement from 0.1 to 1999.9 microseconds • Pulse rate 1, 2, 5, 10 per second, selectable • Resolution 0.1 microseconds • Transmitter output 1200 V • Frequency range 24 to 150 kHz • Receiver imput impedance 1 MOhm • Weight of the tester 0.5 kg, complete set 2.3 kg.
Equipment Photo	
Safety Guidance	<ol style="list-style-type: none"> 1. Do not subject the appliance to impacts or shocks. 2. Do not expose the appliance to fire, extreme temperatures or welding sparks. 3. Do not wash the machine with water.

Equipment Name	50 Litre Drying oven
Brief Description	Use:

	<p>Used for drying materials and test specimens.</p> <p>Specifications:</p> <ul style="list-style-type: none"> • Description: Drying Oven • Capacity, liters: 50 • No. of shelves supplied: 2 • No. of shelf positions: 3 • Temperature Fluctuation: +/- 0.75 °C • Internal Dimensions (length x width x height) mm • 330 x 490 x 330 mm • Temperature Range °C: 40 - 250 °C • Voltage Supply: 220-240 V 50/60 Hz
<p>Equipment Photo</p>	
<p>Safety Guidance</p>	<ol style="list-style-type: none"> 1. Wear thermal insulating gloves when removing hot specimens. 2. Do not put flammable items, including rags or wood, in the ovens. 3. Turn ovens off when not in use

<p>Equipment Name</p>	<p>Blain Air Permeability Apparatus</p>
<p>Brief Description</p>	<p>Use:</p> <p>The apparatus is used for determining the fineness of cement in terms of specific surface expressed as total surface area in square centimeters per gram of cement. This is a variable flow type air permeameter.</p> <p>Specifications:</p> <ul style="list-style-type: none"> • The apparatus consists one each of permeability cell 12.5mm I.D. • Manometer 'U' type mounted on stand with a built in stop cock • Perforated disc • Plunger Rubber stopper • Rubber tube 30cm long • Packet of 12 filter paper discs • bottle of 100cc dibutyphthalate liquid.

Equipment Photo	
Safety Guidance	<ol style="list-style-type: none"> 1. Warning—Mercury has been designated by many regulatory agencies as a hazardous substance that can cause serious medical issues. Mercury, or its vapor, has been demonstrated to be hazardous to health and corrosive to materials. Caution should be taken when handling mercury and mercury containing products. 2. Users should be aware that selling mercury and/or mercury containing products into your state or country may be prohibited by law. 3. The use, lifting, installation, maintenance and scrapping of the machine are allowed only to qualified staff. 4. Verify the accordance of the machine to the standards in force in the State where the machine has to be installed. 5. The machine has to be installed in places safe from fire and explosions.

Equipment Name	Sand Absorption Cone & Tamper
Brief Description	<p>Use: Used for determining the slump of fine aggregate in the determination of bulk and apparent specific gravity and absorption of fine aggregate.</p> <p>Specifications:</p> <ul style="list-style-type: none"> • ASTM C128: Yes • AASHTO T84: Yes • The equipment comprises of A conical Mold: Brass; 40 mm top diam. x 90 mm base diam. x 75 mm h. • Tamper: Steel; 1" diam. working face x 6-5/8" l. (25.4 x 168 mm); 12 oz. (340 g) weight. • Weight: Net 1 lb. (453 g).
Equipment Photo	

Safety Guidance	No special safety rules are needed.
------------------------	-------------------------------------

Equipment Name	Vicat Needle Apparatus
Brief Description	<p>Use: This instrument is used for determining the normal consistency and setting times of cement and 'A' class limes.</p> <p>Specifications:</p> <ul style="list-style-type: none"> • The apparatus consists of a metallic frame bearing a freely movable rod with a cap at top, • Plunger: Reversible; 10 mm diam. at one end and 1 mm diam. needle at other end; combined weight 300 grams. • Needle: Steel; mounted in plunger; 1 mm diam. x 50 mm long. • glass base plate and one set of needles one each initial needle, final needle • Scale Graduated in millimeters. • Mold Hard rubber; 70 mm base diam. x 60 mm top diam. x 40 mm h. • Weight: Net 4 lbs. (1.8 kg).
Equipment Photo	
Safety Guidance	<ol style="list-style-type: none"> 1. Before starting to use the equipment, ensure that all components are in good working order. 2. Check there are no defective or damaged parts. If necessary, repair or replace any damaged part. 3. Do not subject the appliance to impacts or shocks. 4. Do not allow corrosive substances to come into contact with the appliance.

Equipment Name	Cement Soundness Apparatus
Brief Description	<p>Use: To find out the Soundness of Cement.</p> <p>Specifications:</p> <ul style="list-style-type: none"> • Le Chatelier moulds • Glass plates, 50 mm sq. 100 g weights

	<ul style="list-style-type: none"> • Extensibility of mould apparatus • Tamping rod 17 mm dia x 70 g weight • Rule • Weight approx.: 1 kg • Le Chatelier water bath: <ul style="list-style-type: none"> ✓ Stainless steel internal chamber housed in a stainless steel insulated exterior case. Power 1500 W capable of reaching the boiling points in 30 minutes. ✓ 220-240 V, 50-60 Hz, 1 ph. ✓ Dimensions (lxwxd): 300x150x290 mm ✓ Weight approx.: 10.5 kg.
<p>Equipment Photo</p>	
<p>Safety Guidance</p>	<ol style="list-style-type: none"> 1. Do not apply extra pressure while filling the moulds. 2. Be aware while boiling water.

Civil and Environmental Engineering Department
Materials Properties Lab.
Courses Related to Lab: CE 217, CE 318, CE 419

Equipment Name	Concrete Test Hammer
Brief Description	<p>Use:</p> <p>The concrete test hammer is an instrument which is easy to use, for quick and approximate measurement of the resistance to pressure of manufactured concrete products. The principles on which it works are based on the rebound impact of a hammer on a piston which rest against the surface of the concrete products. The Greater the resistance on the concrete, greater is the rebounded impact. By reading this rebound impact on a scale and relating it to curves on graphs supplied with the instrument, the resistance to compression in MPa or PSI can be found, with $\pm 20\%$ of actual.</p> <p>Specifications:</p> <ul style="list-style-type: none"> Consists of a barrel in which is housed a hammer mass attached to an impact spring which slides on a guide bar. A plunger is attached to the guide bar which is pressed against the surface to be tested. As the piston is pressed against the surface to be tested, on reaching the compressive strength, the hammer mass is released and rebounds to a certain extent (according to the strength of the surface) which is indicated by a rider on a calibrated scale. A lock button fixed on the body of the hammer locks the rider in place and the rider can be returned to zero position by using the same button. The equivalent compressive strength can be computed from the chart supplied. Each hammer is calibrated against a standard test hammer, and is suitable for specimen of compressive strengths 100-700 kg/cm². The instrument, complete with a grinding stone for polishing the test surface, is supplied in carrying case.

Equipment Photo	
Safety Guidance	<ol style="list-style-type: none"> 1. Perform the prescribed maintenance work on schedule. 2. Carry out a performance check once the maintenance work has been completed 3. Anyone who is not familiar with the operating instructions must be supervised when using the concrete test hammer.
Equipment Name	Compression Testing Machine
Brief Description	<p>Use: Determining behavior of materials under crushing loads (compression, bending, etc.). Specimen (cubes, cylinders) is compressed, and deformation at various loads is recorded.</p> <p>Specifications:</p> <ul style="list-style-type: none"> • Load is generated via an electro-hydraulic pump integrated in the oil tank and controlled by a precision pressure governor with fine regulating valve and hand wheel. • The power unit together with the micro-processor controlled load indication system with menu control, 5 digit LED display with peak memory and interface RS 232 C with peak output is installed in a separate control cupboard installed to the right of the machine • Load range compression 2000kN • Piston stroke 65 mm • Upper pressure plate 320 mm dia, • Lower pressure plate 300 mm dia • Vertical clearance 340 mm • Safety guards to CE Safety Directive, manufactured from highly resistant transparent polycarbonate material, complete with hinges and lock. The guards are both on front and back sides.

Equipment Photo	
Safety Guidance	<ol style="list-style-type: none"> 1. The testing machine shall be equipped with two steel bearing blocks with hardened faces. 2. Perform the prescribed maintenance work on schedule. 3. Carry out a performance check once the maintenance work has been completed. 4. Anyone who is not familiar with the operating instructions must be supervised when using the machine.

Equipment Name	Stirring heating plate
Brief Description	<p>Use: The stirring heating plate or heated stirring heating plate has been developed to heat and mix fluids contained in laboratory receptacles such as flasks, test tubes and beakers.</p> <p>Specifications:</p> <ul style="list-style-type: none"> • Magnetic Stirrer with Hot Plate 145 mm dia. • Temperature range 500° C, speed range up to 1250 1/min. • Max. Stirring capacity 20 l. 230 V, 50 Hz
Equipment Photo	
Safety Guidance	<ol style="list-style-type: none"> 1. Verify that the heating plate is disconnected and cold. This prevents the risk of electric shock or burns. 2. Clean the equipment in a vertical position to avoid cleaning agents from reaching internal components. 3. Use a mild detergent. 4. Apply to the external surfaces using a piece of cloth of similar texture to that of a handkerchief. 5. Verify that the equipment is completely dry before connecting it again.

Equipment Name	Motorized Flow Table
Brief Description	Use:

	<p>Used for determining the flow of cement concrete.</p> <p>Specifications:</p> <ul style="list-style-type: none"> • Consists of a steel table top 76.2 cm (30 inch dia.), electrically operated, to raise and drop the table top, approx. 15 times in 15 seconds. • The stand is fabricated out of cast iron and is of sturdy construction. • Supplied with one conical mould with handles, 12 cm height having 17 cm. top internal diameter and 25 cm ID at the base. Complete with a tamping rod 16 mm dia x 600 mm long one end rounded. • Power supply : 230 V 1ph 50 Hz 150 W
<p>Equipment Photo</p>	
<p>Safety Guidance</p>	<ol style="list-style-type: none"> 1. Lubricate the axis of the circulator's electric motor. Put a drop of mineral oil on the axis so that a good lubricating condition is maintained between the motor's bearings and its axis. 2. Before carrying out any maintenance activity, disconnect the equipment from the electrical feed outlet. 3. Keep hands, clothing and other objects away from moving parts when the machine is in operation.

<p>Equipment Name</p>	<p>Vibrating Machine</p>
<p>Brief Description</p>	<p>Use:</p> <p>Also called mould vibrator or mortar cube vibrator Concrete moulds are easily cast by using a tamping bar or a vibrating table. However air trapped in cement mortar paste cannot be thus removed while casting cement mortar moulds. Easy method is to impart greater vibration of lesser amplitude to the mould while casting. This is achieved in a vibrating machine. Vibration machine is used for the preparation of mortar cubes for the determination of compression strength of ordinary and rapid hardening portland cement, low heat portland cement, portland blast furnace cement and high alumina cements.</p> <p>Specifications:</p> <ul style="list-style-type: none"> • The machine consists of a vibrating frame assembly and an electric motor mounted on a sturdy base. The complete

	<p>frame assembly consists of a vice to hold a 7.06cm cube mould and two studs threaded at top and a hopper to feed the sample in the mould. This assembly is supported on four springs and has an in built rotating shaft which rotates eccentrically and thus imparts vibrations to the entire frame.</p> <ul style="list-style-type: none"> • The electric motor drives the shaft of the frame and thus imparts required vibrations to the mould. • The frequency of vibration is 12000+/-400 vibration per minute. Supplied complete with on 7.06cm cube mould with loose base plate, a time switch 0-5mins x 1min and certificate of vibration from a standard laboratory. • Spares: Set of springs, Belt and Belt guard. • Power supply: 230V 1ph 50 Hz 250 W • Weight: 100 Kg
Equipment Photo	
Safety Guidance	<ol style="list-style-type: none"> 1. Make sure all people involved are trained and competent to carry out the task at hand and make sure you read and understand the risk assessment and method statement, because if you don't, it'll only come back to bite you later. If you're not sure how to do it, ASK! 2. Wear Personal Protective Equipment (PPE) 3. Before carrying out any maintenance activity, disconnect the equipment from the electrical feed outlet. 4. Keep hands, clothing and other objects away from moving parts when the machine is in operation.

Equipment Name	Lab Concrete Mixer
Brief Description	Use: Used for preparing Mix Design of Concrete.
	Specifications: <ul style="list-style-type: none"> • is a 40" drum heavy duty mixer with ½ yard capacity. • Suitable for Operation on 220 V

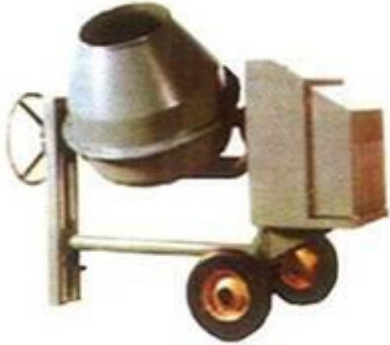
Equipment Photo	
Safety Guidance	<ol style="list-style-type: none"> 1. During operation, provide a safe radius of about 5 feet in front of the mixer to protect spectators from any possible unexpected release of material. 2. Standing behind the mixer is prohibited during mixing! 3. Keep hands free of any joints and moving parts at all times. 4. Do not leave the mixer unattended when running. 5. Make sure the drum is securely locked with the lock lever in down position at all times. 6. Be aware that the mixing drum and wheel may immediately rotate into a balanced position by force of gravity once the lock lever is released. 7. Always turn the power off and unplug the power cord when the mixer is not in use! 8. The mixer must be cleaned completely when work is finished. Pour excess concrete over a screen into the sump and rinse the mixer until the inside is free of material. Leave the mixer in a position so all water may drain. Once the mixer drum is dry inside, it shall be moved into the balanced position

Equipment Name	Vibrating Table
Brief Description	<p>Use: Used for proper compaction and consolidation of cement and concrete while casting specimens for compressive or flexural strength testing essential to achieve a better and more consistent mixture.</p> <p>Specifications:</p> <ul style="list-style-type: none"> • It is designed to carry a load of 140 kg. The apparatus consists of a motor fitted with a variable pitch pulley housed in a cabinet. • The vibrations are imparted by means of off-balance masses rotating on a shaft of a vibrator clamped to the underside of the table top. • The table top is 50cm x 50cm. and has stops along its edges to prevent moulds from walking off the table during vibration. A cross arm adjustable on a vertical rod at the center of the table is provided to hold the moulds while operating the table.

	<ul style="list-style-type: none"> • The variable pitch pulley arrangement permits the frequency to be varied sleeplessly between a maximum of 3600 vibrations down to 2600 vibrations per minute. • A speed regulation handle is provided for increasing or decreasing the frequency.
Equipment Photo	
Safety Guidance	<ol style="list-style-type: none"> 1. It shall only be operated by, or under attendance of the laboratory supervisor. 2. Always turn the power off and unplug the power cord when the machine is not in use!

Equipment Name	Needle Vibrator
Brief Description	Use: Used for proper compaction and consolidation of cement and concrete while casting specimens.
	Specifications: <ul style="list-style-type: none"> • Speed: 10,000 • Description: Laboratory Vibrator • Tip: 1-3/8" diam. x 14 " l. (35 x 35 6 mm). • Shaft: 24 " l. (610 mm). • Speed: 10,000 rpm. • Motor: Electric. • Weight: Net 14 lbs. (6.3 kg).
Equipment Photo	
Safety Guidance	<ol style="list-style-type: none"> 1. Wear eye , shoes and ear protection.

Equipment Name	Cutting Machine
Brief Description	<p>Use: Cutting Machine for diamond saw blades up to 450 mm dia. Cutting depth max. 180 mm, cutting length 600 mm with water cooling installation with circulation pump and electric motor 2500 1/min. Supplied with under frame. 400 V, 50 Hz, 3 P+N+PE.</p> <p>Specifications:</p> <ul style="list-style-type: none"> • Max. cutting height: 115 mm with 350 mm dia. blade and 165 mm with 450 mm dia. blade • Max. blade diameter: 450 mm • Power: 3 kW • Overall dimensions (lxdxh): 1300x700x700 mm • Weight approx.: 92 kg
Equipment Photo	
Safety Guidance	<ol style="list-style-type: none"> 2. Before using the saw, make sure that the correct, material specific cut-off wheel is installed. 3. Disconnect the power cord before cleaning, changing blades, or making any adjustments to the saw. Always unplug the power cord when carrying the saw. 4. Do not use the saw for cuts unless you can safely support and hold the material being cut. - Before cutting small work pieces, the lab supervisor should be consulted. 5. Keep your head out of the path of particles thrown out by the blade. 6. Wear eye and ear protection. 7. Keep flammables away from the saw at a safe distance as cutting steel creates sparks. 8. Never wedge, wire, or otherwise jam the guard to prevent it from working. 9. Wait until the saw stops before lifting it from a cut. 10. Before setting the saw down, make sure the guard is closed, as the blade may still be turning. 11. Don't pull the saw backwards in a cut if you can avoid it. 12. Do not use the power hand saw for cuts if you cannot keep a firm and secure grip on the saw and the material being cut. A hand saw is still the best for some kinds of work and often faster.

Equipment Name	Vebe Test Apparatus
Brief Description	Use: Used to measure the consistency of stiff to extremely dry concrete. The assembly is mounted upon a small vibrating table operating at a fixed amplitude and frequency. The time to complete the required vibration gives an indication of the concrete consistency.
	Specifications: <ul style="list-style-type: none"> • Vibro Consistometer (Vebe), 380x260±3mm (LxW), • cylindrical bucket with base dia. Ø240±5mm, height: 200±2mm cylindrical bucket • slump cone with base dia: Ø200x upper dia: Ø100 x height: 300±2mm slump cone, Ø230±2mm. • The set consists of vibrating table, slump cone, graduated rod with transparent plate, filling cone and tamping rod.
Equipment Photo	
Safety Guidance	<ol style="list-style-type: none"> 1. Use hand gloves, shoes at the time of test. 2. Keep the mould & flow table clean, dry & free from sticking concrete. 3. Keep the vertical shaft lubricated with light oil. 4. Keep the contact faces of the flow table top & supporting frame oiled. 5. Turn off when not in use.

Equipment Name	Core Drilling Machine
Brief Description	Use: The Core Drilling Machine is made to drill holes in granite, masonry and steel reinforced concrete.
	Specifications: <ul style="list-style-type: none"> • Shaft thread: 1¼-7. • Power: 2200 W at 230 V; 1800 W at 110 V. • Full load speed: 670/1140/1580 r.p.m. • Coring range dia.: 35/150 mm. • Dimensions approx.: 451x290x860 mm. • Weight approx.: 36 kg.

Equipment Photo	
Safety Guidance	<ol style="list-style-type: none"> 1. Make sure Core Drilling Machine is unplugged and the drill mast switch is set to the OFF position. 2. Inspect the vacuum seal for wear or damage. Replace if necessary. 3. Inspect the power cord and plug for damage. If the plug has been modified, is missing the grounding prong or if the cord is damaged, do not use the Threading Machine until the cord has been replaced. 4. Inspect the Core Drilling Machine for any broken, missing, misaligned or binding parts as well as any other conditions which may affect the safe and normal operation of the machine. If any of these conditions are present, do not use the machine until any problem has been repaired. 5. Lubricate the Core Drilling Machine if necessary according to the Maintenance Instructions. 6. Use drill bits and accessories that are designed for your Core Drilling Machine and meet the needs of your application. The correct tools and accessories allow you to do the job successfully and safely. Accessories designed for use with other equipment may be hazardous when used with the Core Drilling Machine. 7. Clean any oil, grease or dirt from all handles and controls. This reduces the risk of injury due to a tool or control slipping from your grip. 8. Inspect the cutting edges of your drill bits. If necessary, have them replaced prior to using the Core Drilling Machine. Bit is considered worn when the crown shows excessive wear and has become flush with tube. Dull or damaged cutting tools can lead to binding and tool breakage.

Equipment Name	110 Litre Drying oven
Brief Description	<p>Use: Used for drying materials and test specimens.</p> <p>Specifications:</p> <ul style="list-style-type: none"> • Capacity, litres: 100 • No. of shelves supplied: 3 • No. of shelf positions: 4 • Temperature Fluctuation: +/- 0.75 °C

	<ul style="list-style-type: none"> • Internal Dimensions (length x width x height) mm: 460 x 490 x 450 mm • Temperature Range °C: 40 - 250 °C • Voltage Supply: 220-240 V 50/60Hz
Equipment Photo	
Safety Guidance	<ol style="list-style-type: none"> 1. Wear thermal insulating gloves when removing hot specimens. 2. Do not put flammable items, including rags or wood, in the ovens. 3. Turn ovens off when not in use

Equipment Name	Compaction Factor Apparatus
Brief Description	<p>Use: The apparatus is used for determining the workability of fresh concrete, provided the maximum size of the aggregate does not exceed 38mm. The test is particularly useful for concrete mixes of very low workability where true slump values are not reliable.</p> <p>Specifications:</p> <ol style="list-style-type: none"> 1. It consists of two rigid conical hoppers and a cylinder mounted on a rigid metal frame. 2. The lower openings of the hoppers are fitted with hinged trapdoors having a quick release catches. 3. A circular metal plate is provided to cover the top of the cylinder. 4. Supplied complete with one tamping rod, 16mm dia x 600mm long, both ends rounded.
Equipment Photo	
Safety Guidance	<ol style="list-style-type: none"> 1. ALWAYS level the device prior to operation.

	<ol style="list-style-type: none"> 2. Use caution to avoid pinching fingers. 3. ALWAYS wear safety glasses when operating, maintaining this device.
--	---

Equipment Name	Air Entrainment Meter
Brief Description	<p>Use: Used to measure the air content of freshly mixed mortar in accordance with the air pressure compensation principle.</p> <p>Specifications:</p> <ul style="list-style-type: none"> • Air Entrainment Meter - B Type • External Dimensions dia x height: 9.75 x 13.25 • ASTM C231: Yes • AASHTO T152: Yes • Capacity: 7 Litres • Readings: Up to 22% entrained air • Accuracy: 1/4% full scale • Aggregate Size: 2" (50.8 mm) maximum • Container: With tare weight stamped on bottom; 2-piece clamping device for positive seal. • Water: 4 oz required • Initial Pressure: Approx. 10 strokes needed • Pressure Gauge: In shock-proof mounting • Tamping Rod: Aluminium; 24" (610 mm) long • Dimensions: 9-3/4" diam. X 13-1/4" h. (248 x 337 mm) • Weight: Net 15 lbs (8 kg)
Equipment Photo	
Safety Guidance	<ol style="list-style-type: none"> 1. The person operating these systems must take care that he or she does not endanger the health and safety of himself/herself or of any other persons. 2. No person may operate this system without supervision unless he or she has received sufficient instruction in its operation. 3. If these air entrainment meters are damaged, or have any malfunctions that can impair their operational safety, they must be immediately placed out of operation and the malfunctions must be corrected. 4. These systems may not be further operated until all such malfunctions or shortcomings have been eliminated. 5. These air entrainment meters may be used only: <ol style="list-style-type: none"> a. For the purpose for which they were intended

	b. In a technical condition in which they can be perfectly safely operated.
--	---

Equipment Name	Metal locator
Brief Description	<p>Use: Locate embedded metal before your drill bit or saw blade does. This powerful dedicated metal scanning tool can locate metal up to 6 inches deep in solid concrete.</p> <p>Specifications:</p> <ul style="list-style-type: none"> • Zircon MetalliScanner® MT 6 • Dimensions 8.94 in. H x 3.84 in. W x 2.23 in. D (227 mm x 98 mm x 57 mm) • Weight 9.17 oz. (260 g) without battery • Battery Type 9V alkaline (not included) • Position Center of #4 (½ in.) rebar or ½ in. • Accuracy (13 mm) copper pipe at a minimum grid spacing of 6 in. (152 mm) typically within ½ in. (13 mm) • Depth* Up to 6 in. (152 mm) ± 1 in. (25 mm) • Operating 20° to 105°F (-7° to 41°C) • Temperature Storage -20° to 150°F (-29° to 66°C) • Temperature Humidity 5-90% RH non-condensing Water Splash and Water resistant, not Resistance waterproof.
Equipment Photo	
Safety Guidance	<ol style="list-style-type: none"> 1. Always turn off power when working near electrical wires. 2. In situations involving multiple, closely spaced targets, the MT 6 may be unable to detect the exact location and/or depth of each piece of metal. Always use caution and wear safety glasses when nailing, cutting, or drilling in walls, floors, and ceilings that may contain metal objects. 3. If a magnetic and nonmagnetic object (ex., rebar and copper pipe) are positioned side-by-side or on top of each other, the MT 6 may have difficulty locating them 4. MT 6 is designed to operate at approximately 70°F (21°C). Sensitivity decreases slightly at higher temperatures, but is not noticeably affected at lower temperatures

Civil and Environmental Engineering Department
Structural Engineering Lab
Courses Related to Lab: CE 214, CE 215, CE 316

Equipment Name	Universal Test Frame
Brief Description	<p>Use: The Universal Test Frame enables testing large scale concrete and steel structures. Testing frame was also used to test concrete structures strengthened with FRP and wood joists</p> <p>Specifications: The frame is meant to be connected to an existing AUTOMAX E control</p>
Equipment Photo	
Safety Guidance	<ol style="list-style-type: none"> 1. Do not use a machine if you have not been shown how to operate it safely 2. Wear shoes that adequately cover the whole foot 3. Never wear loose clothes , Wear lab coat 4. Keep hands away from moving/rotating machinery 5. Avoid shock and jerking of hoist load chain 6. Always use a guard when working on a machine 7. DO NOT leave suspended load unattended.

Equipment Name	Suspension Bridge
Brief Description	Use:

	<p>to investigate the structure under a wide range of load conditions. The bridge loaded is through a number of weights, each having a specific loading value. Point loads can be applied by means of known weights, which can be positioned easily on the bridge deck.</p> <p>Specifications:</p> <ul style="list-style-type: none"> • Parabolic arch hinged at the crown and abutments of 1m span and 0.2m rise. The arch has 9 loading points and a balanced reaction force measuring system for the “free end” which ensures the correct arch shape is maintained
<p>Equipment Photo</p>	
<p>Safety Guidance</p>	<ol style="list-style-type: none"> 1. Do not use a machine if you have not been shown how to operate it safely 2. Wear shoes that adequately cover the whole foot 3. Never wear loose clothes , Wear lab coat 4. Keep hands away from moving/rotating machinery 5. Avoid shock and jerking of hoist load chain 6. Always use a guard when working on a machine 7. DO NOT leave suspended load unattended.

Civil and Environmental Engineering Department
Water Resources Lab
Courses Related to Lab: CE241 - CE 498 - CE 499

Equipment Name	Open channel flow with its accessories
Brief Description	Use: Ability to understand the water flow in channels
	Specifications: <ul style="list-style-type: none"> To measure the flow of water in open channels.
Equipment Photo	
Safety Guidance	<ol style="list-style-type: none"> 1. You must be trained in the safe use of the water pump before operating it. 2. Ensure that wall sockets are properly protected before using the water pump. 3. Ensure that students are instructed not to plug or unplug energized equipment when their hands are wet, 4. Ensure that electrical cords do not lie in water. 5. Observe proper housekeeping. Keep work areas uncluttered, and clean frequently. 6. Put unneeded materials back in storage promptly. 7. Keep aisles, doors, and access to emergency equipment unobstructed at all times.

Civil and Environmental Engineering Department
Environmental Engineering Lab.
Courses Related to Lab: CE 360 and CE 363

Equipment Name	UV - Vis spectrophotometer
Brief Description	Use: To determine the impurities in organic molecules by measuring the absorbance at specific wavelength.
	Specifications: <ul style="list-style-type: none"> • It can characterize compounds which absorbs UV radiation. Identification is done by comparing the absorption spectrum with the spectra of known compounds. UV absorption spectroscopy is generally used for characterizing aromatic compounds and aromatic olefins.
Equipment Photo	
Safety Guidance	<ol style="list-style-type: none"> 1. Inspect the instrument for any signs of damage caused during transit. 2. The instrument must be placed on a stable, level bench or table capable of taking its weight with sufficient space around the instrument for ventilation to circulate freely 3. The equipment must be connected to the local supply outlet using the provided power cables, compatible voltages are shown in the table below.

Equipment Name	Jar Test Apparatus
Brief Description	Use:

	<p>To select and quantify a treatment program for removal of suspended solids or oil from raw water or a dilute process or waste stream.</p> <p>Specifications:</p> <ul style="list-style-type: none"> It is used in flocculation and coagulation experiments with different water sources to measure the optimum required doses of coagulants then know water characteristics and amount of sludge formed.
Equipment Photo	
Safety Guidance	<ol style="list-style-type: none"> Watch out the main features of the laboratory jar testers are the continuously variable stirring speed. The digital display of stirring rpm, the timer function should be fixed accurately.

Equipment Name	Analytical balance
Brief Description	<p>Use:</p> <p>To measure small <u>mass</u> in the sub-milligram range.</p> <p>Specifications:</p> <ul style="list-style-type: none"> To measure mass very precisely. The device has reading error of +/- 0.05 gram.
Equipment Photo	
Safety Guidance	<ol style="list-style-type: none"> Hands free operation No contaminants. The instrument must be placed on a stable, level bench or table capable of taking its weight with sufficient space around the instrument for ventilation to circulate freely

Equipment Name	Magnetic Stirrer Hot plate with Stand
Brief Description	Use:

	<p>It employs a rotating magnetic field to cause a <u>stir bar</u> (also called "flea") immersed in a liquid to spin very quickly.</p> <p>Specifications:</p> <ul style="list-style-type: none"> • A stir bar is the <u>magnetic</u> bar placed within the liquid which provides the stirring action.
Equipment Photo	
Safety Guidance	<ol style="list-style-type: none"> 1. Inspect the instrument for any signs of damage caused during transit. 2. The instrument must be placed on a stable, level bench or table capable of taking its weight with sufficient space around the instrument for ventilation to circulate freely

Equipment Name	Portable DO Meter – Bench top
Brief Description	<p>Use: Portable meter provides reliable and high quality dissolved oxygen (DO) measurements with simple click of a button</p> <p>Specifications: Orion™ Star A213 RDO / DO Benchtop Meter</p>
Equipment Photo	
Safety Guidance	<ol style="list-style-type: none"> 1. Take the guesswork out of testing with plain-language screen prompts and function keys that update for easy selection. 2. Prepare every sample for every day.

Equipment Name	Conductivity Meter – Bench top
Brief Description	<p>Use: A conductivity meter can obtain not only electrical conductivity measurements, but total dissolved solid (TDS), pH, percent NaCl, resistance, and temperature measurements as well.</p> <p>Specifications:</p> <ul style="list-style-type: none"> • A benchtop conductivity meter can have a conductivity range of 0.001 uS/cm to 1000 mS/cm or greater, and offer linear, non-linear, automatic (ATC) temperature compensation, or manual

	temperature compensation (MTC). Particular features include high reproducibility, calibration reminders, multiple calibration points, and generous data storage.
Equipment Photo	
Safety Guidance	<ol style="list-style-type: none"> 1. Inspect the instrument for any signs of damage caused during transit. 2. The instrument must be placed on a stable, level bench or table capable of taking its weight with sufficient space around the instrument for ventilation to circulate freely. 3. The equipment must be connected to the local supply outlet using the provided power cables, compatible voltages are shown in the table below.

Equipment Name	pH Meter – Bench top
Brief Description	Use: To measure the acidity and alkalinity of liquid or semi-solid samples.
	Specifications: <ul style="list-style-type: none"> • The pH is the unit of measure that describes the degree of acidity or alkalinity. It is measured on a scale of 0 to 14.
Equipment Photo	
Safety Guidance	<ol style="list-style-type: none"> 1. Inspect the instrument for any signs of damage caused during transit. 2. The instrument must be placed on a stable, level bench or table capable of taking its weight with sufficient space around the instrument for ventilation to circulate freely. 3. The equipment must be connected to the local supply outlet using the provided power cables, compatible voltages are shown in the table below.

Equipment Name	Portable UV- Spectrometer
Brief Description	Use: To measure color or samples UV- length outside the laboratory.
	Specifications:

	<ul style="list-style-type: none"> The USB4000-UV-VIS is a miniature spectrometer preconfigured for general UV-Vis measurements from 200-850 nm including absorption, transmission, reflectance and emission.
Equipment Photo	
Safety Guidance	<ol style="list-style-type: none"> 1. Inspect the instrument for any signs of damage caused during transit. 2. The instrument must be placed on a stable, level bench or table capable of taking its weight with sufficient space around the instrument for ventilation to circulate freely. 3. The equipment must be connected to the local supply outlet using the provided power cables, compatible voltages are shown in the table below.

Civil and Environmental Engineering Department

Hydraulics Lab.

Courses Related to Lab: CE240 – CE241 – CE 498 – CE 499

Equipment Name	Basic Metacentric Height
Brief Description	Use: This equipment enables a thorough investigation of the factors affecting the stability of a floating body.
	Specifications: <ul style="list-style-type: none">• Determining the centre of gravity of the pontoon
Equipment Photo	
Safety Guidance	<ul style="list-style-type: none">• Observe proper housekeeping. Keep work areas uncluttered, and clean frequently.• Put unneeded materials back in storage promptly.• Keep aisles, doors, and access to emergency equipment unobstructed at all times.

Equipment Name	Bernoulli's Theorem Demonstration unit
Brief Description	Use: This accessory demonstrates the application of Bernoulli's Theorem and circumstances where it does not apply; Directly measuring the static and total head distribution along a Venturi tube.
	Specifications: <ul style="list-style-type: none">• The Venturi can be demonstrated as a means of flow measurement and the discharge coefficient can be determined.

Equipment Photo	
Safety Guidance	<ol style="list-style-type: none"> 1. Ensure that students are instructed not to plug or unplug energized equipment when their hands are wet, 2. Ensure that electrical cords do not lie in water.

Equipment Name	Centrifugal Pump Characteristics
Brief Description	<p>Use: Converts input power to kinetic energy by accelerating liquid in a revolving device - an impeller.</p>
	<p>Specifications:</p> <ul style="list-style-type: none"> • controls the kinetic energy of a liquid coming out of an impeller
Equipment Photo	
Safety Guidance	<ol style="list-style-type: none"> 1. You must be trained in the safe use of the water pump before operating it. 2. Ensure that wall sockets are properly protected before using the water pump. 3. Ensure that students are instructed not to plug or unplug energized equipment when their hands are wet, 4. Ensure that electrical cords do not lie in water.

Equipment Name	Dead weight calibration unit
Brief Description	<p>Use: Can measure the pressure and effective area of the gauge determined.</p>

	<p>Specifications:</p> <ul style="list-style-type: none"> The calibrated characterization of <u>deadweight testers</u> involves the transfer of effective areas of one piston and cylinder to another utilizing pressure based cross-float techniques.
Equipment Photo	
Safety Guidance	<ol style="list-style-type: none"> Observe proper housekeeping. Keep work areas uncluttered, and clean frequently. Put unneeded materials back in storage promptly. Keep aisles, doors, and access to emergency equipment unobstructed at all times.

Equipment Name	Flow visualization unit
Brief Description	<p>Use:</p> <p>It is used to make the <u>flow</u> patterns visible, in order to get qualitative or quantitative information on them.</p>
	<p>Specifications:</p> <ul style="list-style-type: none"> Flow visualization is the art of making flow patterns visible. Most <u>fluids</u> (air, water, etc.) are <u>transparent</u>, thus their flow patterns are invisible to the naked eye without methods to make them visible.
Equipment Photo	
Safety Guidance	<ol style="list-style-type: none"> Ensure that wall sockets are properly protected before using the water pump. Ensure that students are instructed not to plug or unplug energized equipment when their hands are wet, Ensure that electrical cords do not lie in water.

Equipment Name	hydraulic bench
-----------------------	------------------------

Brief Description	Use: Hydraulic bench is a very useful apparatus in hydraulics and fluid mechanics. It is involved in majority of experiments to be conducted e.g. To find the value of the co-efficient of velocity, coefficient of discharge, to study the characteristics of flow over notches. To find metacentric height, to find head losses through pipes, to verify Bernoulli's theorem etc.
	Specifications: Provides a controlled recirculating water supply and accurate flow meter for hydraulic and fluid mechanics experiments.
Equipment Photo	
Safety Guidance	<ol style="list-style-type: none"> 1. Do not operate any of the equipment unless you have been trained and authorized to do so. 2. Ensure that wall sockets are properly protected before using the water pump. 3. Ensure that students are instructed not to plug or unplug energized equipment when their hands are wet, 4. Ensure that electrical cords do not lie in water.

Equipment Name	Hydrostatic Pressure Unit
Brief Description	Use: The Hydrostatic Pressure accessory has been designed to determine the static thrust exerted by a fluid on a submerged surface and enables comparison of the measured magnitude and position of this force with simple theory.
	Specifications: <ul style="list-style-type: none"> • Determining the centre of pressure on both a submerged or partially submerged plane surface and comparison with the theoretical position

Equipment Photo	
Safety Guidance	<ol style="list-style-type: none"> 1. Observe proper housekeeping. Keep work areas uncluttered, and clean frequently. 2. Put unneeded materials back in storage promptly. 3. Keep aisles, doors, and access to emergency equipment unobstructed at all times.

Equipment Name	Impact of jet
Brief Description	<p>Use: To investigate the reaction force produced by the impact of a jet of water on to various target vanes.</p>
	<p>Specifications:</p> <ul style="list-style-type: none"> • Impact of jets apparatus enables experiments to be carried out on the reaction force produced on vanes when a jet of water impacts on to the vane.
Equipment Photo	
Safety Guidance	<ol style="list-style-type: none"> 1. Do not operate any of the equipment unless you have been trained and authorized to do so. 2. Ensure that wall sockets are properly protected before using the water pump. 3. Ensure that students are instructed not to plug or unplug energized equipment when their hands are wet, 4. Ensure that electrical cords do not lie in water.

Equipment Name	Notches
Brief Description	Use: To determine the Flow rate through different Notches.
	Specifications: <ul style="list-style-type: none"> To Determination Co-efficient of discharge (CD) through :V notch (45 deg. and 60 deg.); Rectangular Notch and Trapezoidal Notch
Equipment Photo	
Safety Guidance	<ol style="list-style-type: none"> 1. Ensure that students are instructed not to plug or unplug energized equipment when their hands are wet, 2. Ensure that electrical cords do not lie in water.

Equipment Name	Orifice and Free jet flow unit
Brief Description	Use: This equipment permits calibration of two orifices of differing diameter and enables the trajectory of the jet to be plotted.
	Specifications: <ul style="list-style-type: none"> Establishing the coefficient of velocity for a small orifice; Finding the coefficient of discharge for a small orifice with flow under constant head and flow under varying head and comparing the measured trajectory of a jet with that predicted by simple theory of mechanics
Equipment Photo	
Safety Guidance	<ol style="list-style-type: none"> 1. Do not operate any of the equipment unless you have been trained and authorized to do so. 2. Ensure that wall sockets are properly protected before using the water pump.

	<ul style="list-style-type: none"> • Ensure that students are instructed not to plug or unplug energized equipment when their hands are wet, • Ensure that electrical cords do not lie in water.
--	--

Equipment Name	Orifice Discharge unit
Brief Description	<p>Use: Orifice is a simple device used to measure fluid flow in pipes.</p> <p>Specifications: The Orifice Discharge accessory enables full analysis of the flow through seven different orifices over a range of flow rates.</p>
Equipment Photo	
Safety Guidance	<ol style="list-style-type: none"> 1. Do not operate any of the equipment unless you have been trained and authorized to do so. 2. Ensure that wall sockets are properly protected before using the water pump. 3. Ensure that students are instructed not to plug or unplug energized equipment when their hands are wet, 4. Ensure that electrical cords do not lie in water.

Equipment Name	Pipe fitting apparatus
Brief Description	<p>Use: The unit provides study of loose pipe in various pipe fitting. A differential manometer supply to measure the loss of head in these fitting. A flow control valve is provided. An experiment can be carried out at various flow rates.</p> <p>Specifications: Testing of pipe circuit consisting of sudden contraction, sudden enlargement bends and measurement of head loss at each section for various flows.</p>
Equipment Photo	

Safety Guidance	<ol style="list-style-type: none"> 1. Do not operate any of the equipment unless you have been trained and authorized to do so. 2. Ensure that wall sockets are properly protected before using the water pump. 3. Ensure that students are instructed not to plug or unplug energized equipment when their hands are wet, 4. Ensure that electrical cords do not lie in water.
------------------------	---

Equipment Name	Fluid Properties & Hydrostatics Bench
Brief Description	<p>Use: Fluid Properties and Hydrostatics Bench is designed to demonstrate the properties of fluids and their behavior under hydrostatic conditions (fluid at rest).</p> <p>Specifications:</p> <ul style="list-style-type: none"> • To study various fluids and their properties. Experiments include: Measure density, specific gravity, or viscosity; Use of a manometer, a barometer or Pascal's Apparatus to study pressure; measuring change in liquid level with Hook & Point Gauge; and investigating the effect of flow on a free surface.
Equipment Photo	
Safety Guidance	<ol style="list-style-type: none"> 1. Do not operate any of the equipment unless you have been trained and authorized to do so. 2. Observe proper housekeeping. Keep work areas uncluttered, and clean frequently. 3. Put unneeded materials back in storage promptly. 4. Keep aisles, doors, and access to emergency equipment unobstructed at all times.

Acknowledgements

The vice deanship for quality and development in the college of engineering would like to produce deep gratitude to everyone participated in creating this valuable booklet.

Deep thanks to his Excellency the dean of the college of engineering Dr. Abdullah Al-Muhaisen for the supervision and the valuable instructions.

Continuous gratitude to Dr. Sameh Ahmed for his efforts in reviewing this lab booklet and for the valuable instructions.

Deep thanks to all the lab supervisors in the college for the huge effort to offer, collect and rearrange all the data related to the labs in the college.

Title: Lab equipment Booklet		
Doc. No.:	Version:	Date:
Recommended: Vice Deanship for Academic Affairs		
Approved by: Dr. Abdullah Alabdulkareem- Dean of College of Engineering		